

# BLOX TYP 25

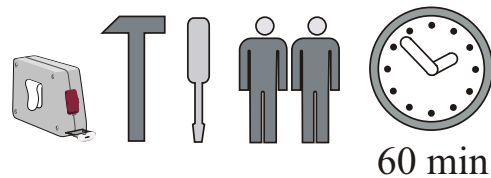
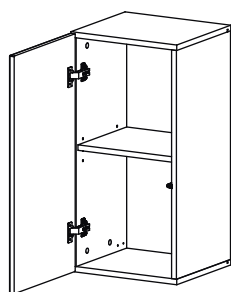
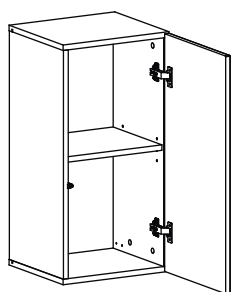
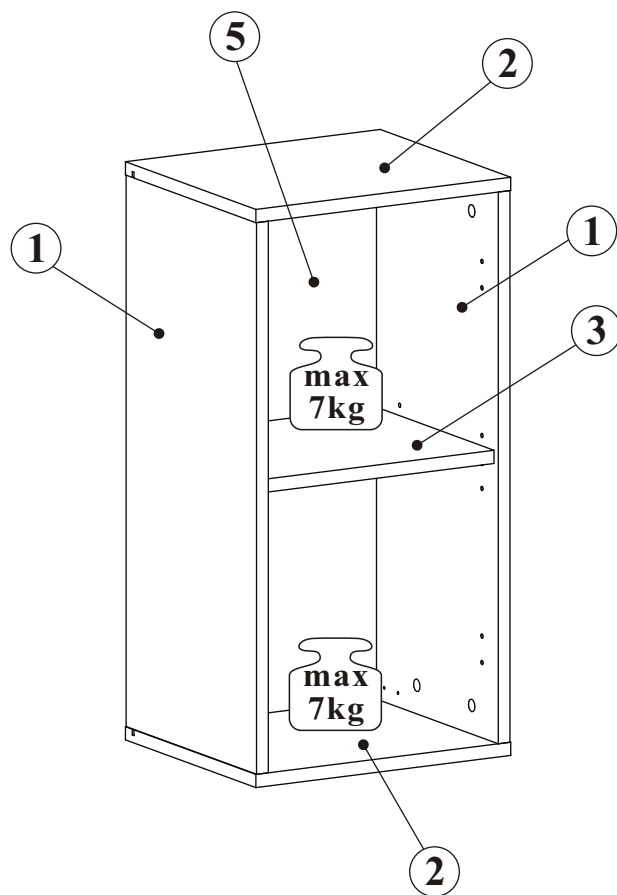
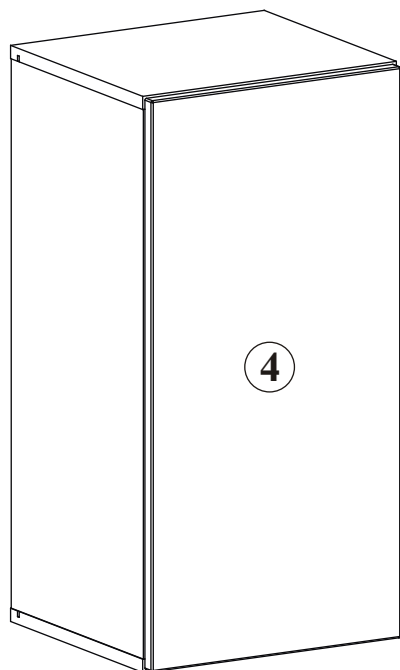
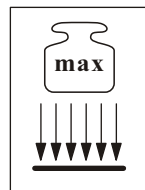

NO	Dim.		Col.-No	Qty
1	667	304	1	2
2	349	304	1	2
3	315	274	1	1
4	343	693	1	1
5	679	327	1	1

# BLOX TYP 25

A1 x8 ø8x36	B4 x8	B5 x8 Ø15x12	G5 x8	ZR1 x2	D6 x4 USØ3,5x30
E21 x2 Ø35 H=0	E2 x2 H=0	D10 x6 USØ3,5x13	Z2 x4 Ø5	T1 x1	G7 x4
S1 x6	KR2 x2	G2 x1			

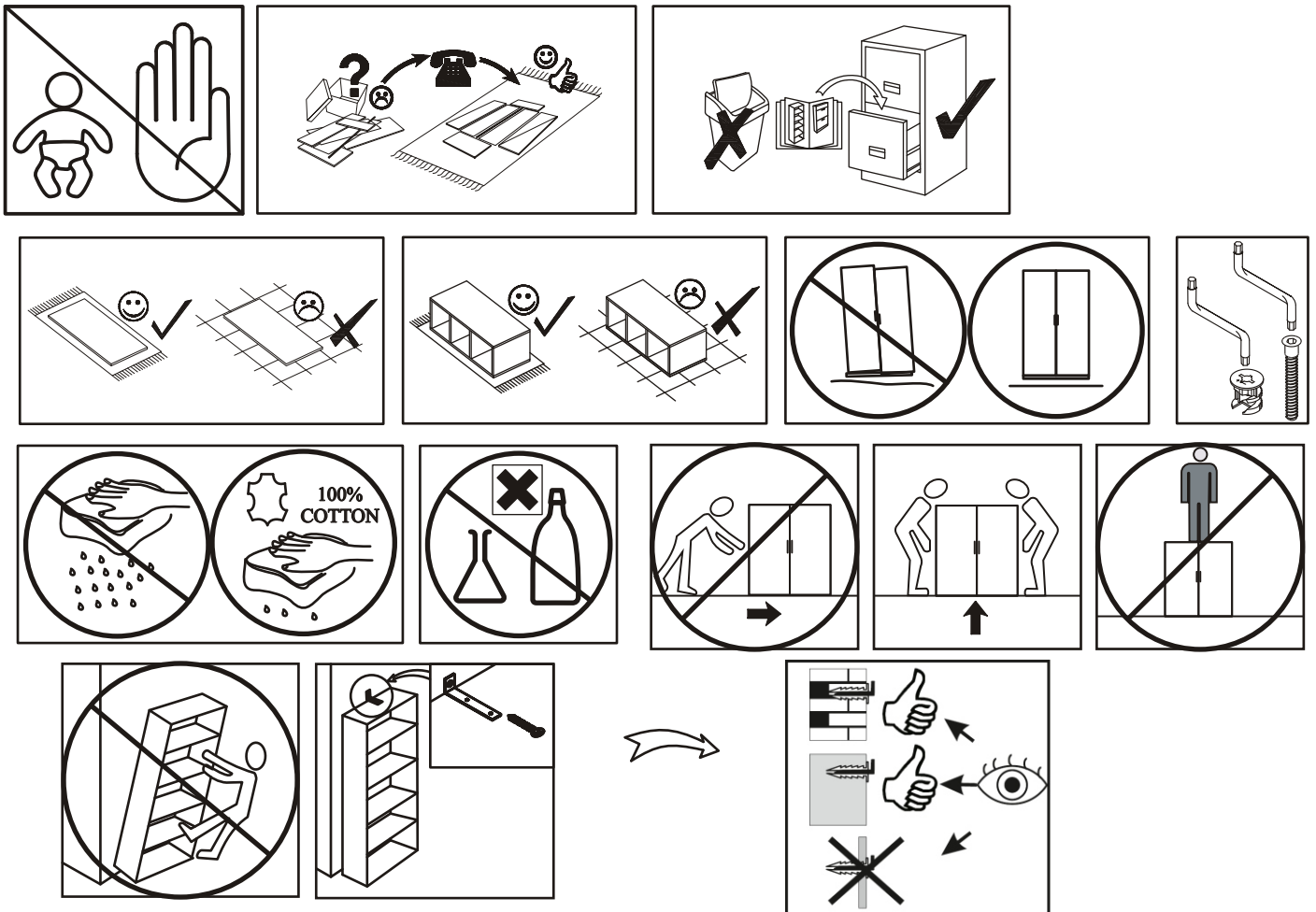
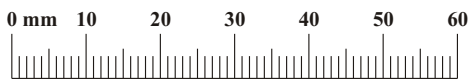

BLOX TYP 25

A1	
x8	ø8x36

B5	
x8	Ø15x12

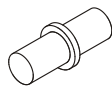
G7	
x4	

1

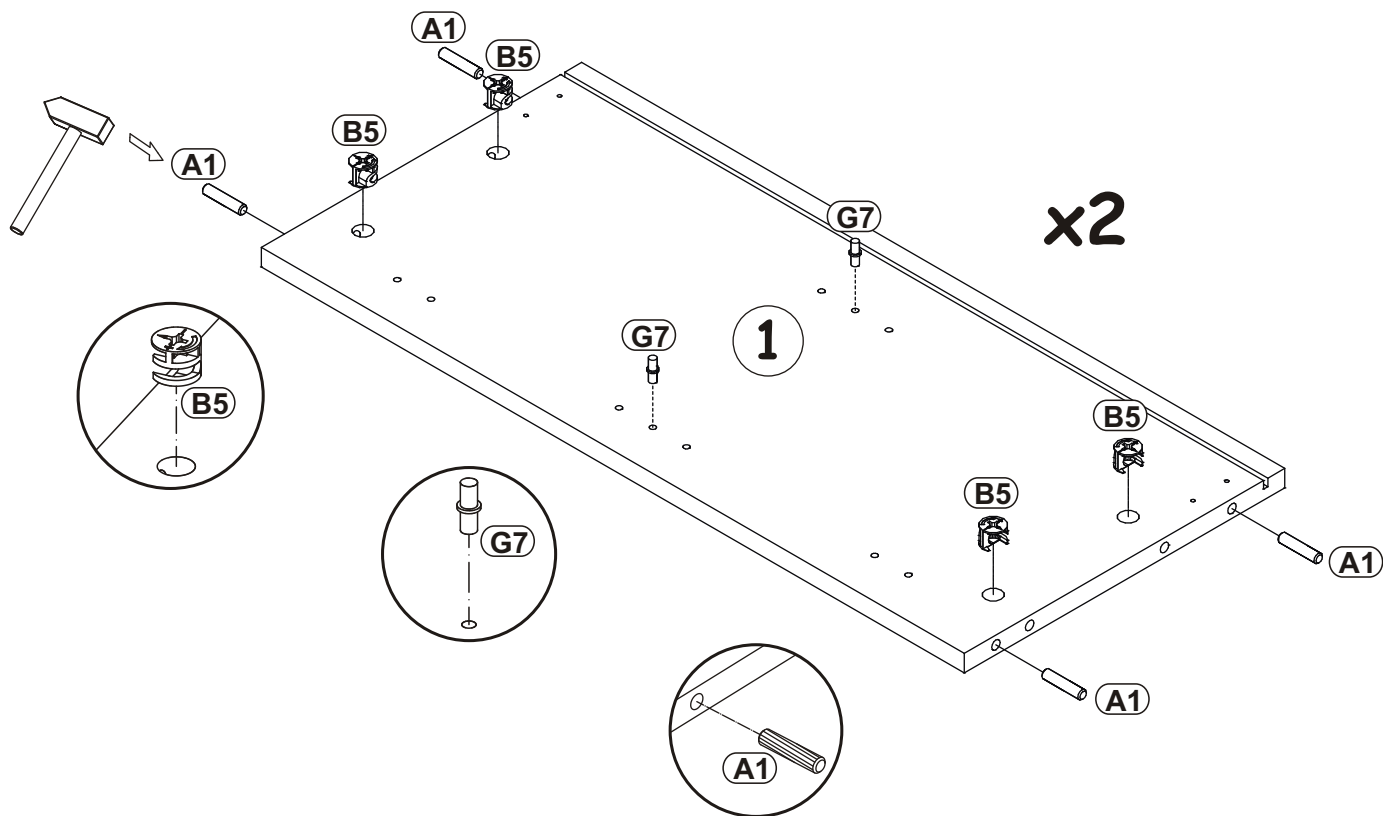

2

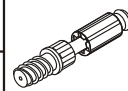
B4	
x8	

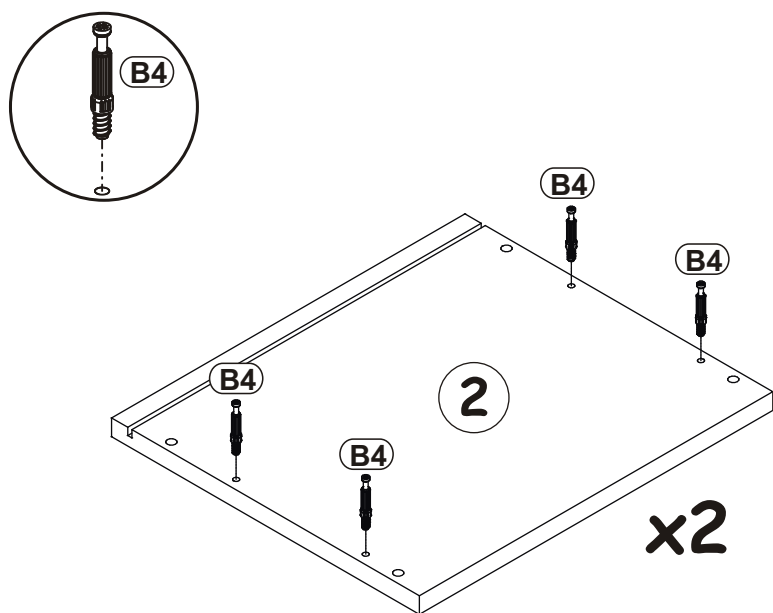

# BLOX TYP 25

3

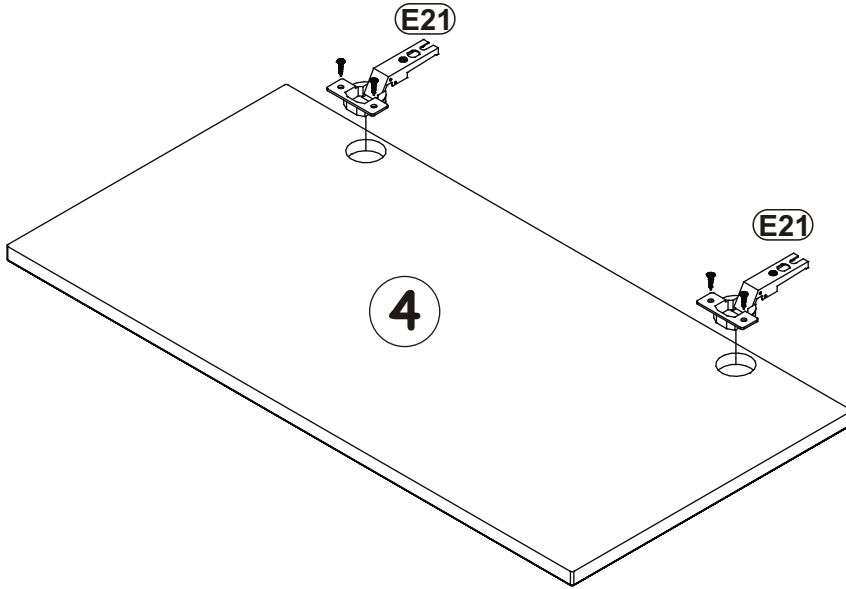
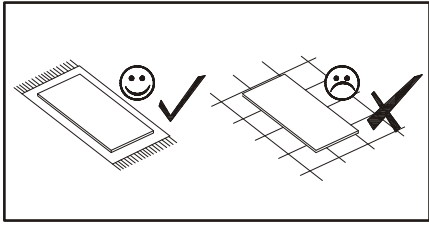

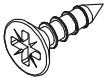
E21	Ø35	D10	 USØ3,5x13
x2	H=0	x4	

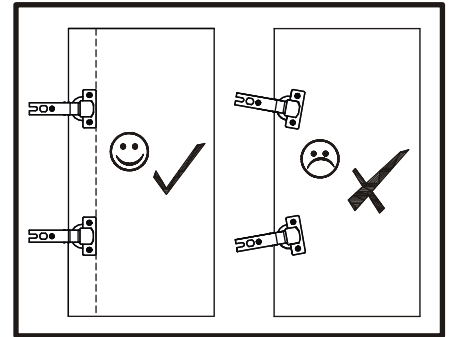
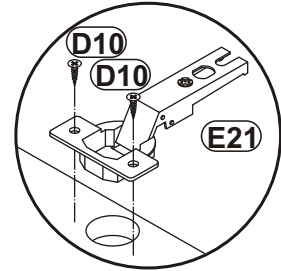

4

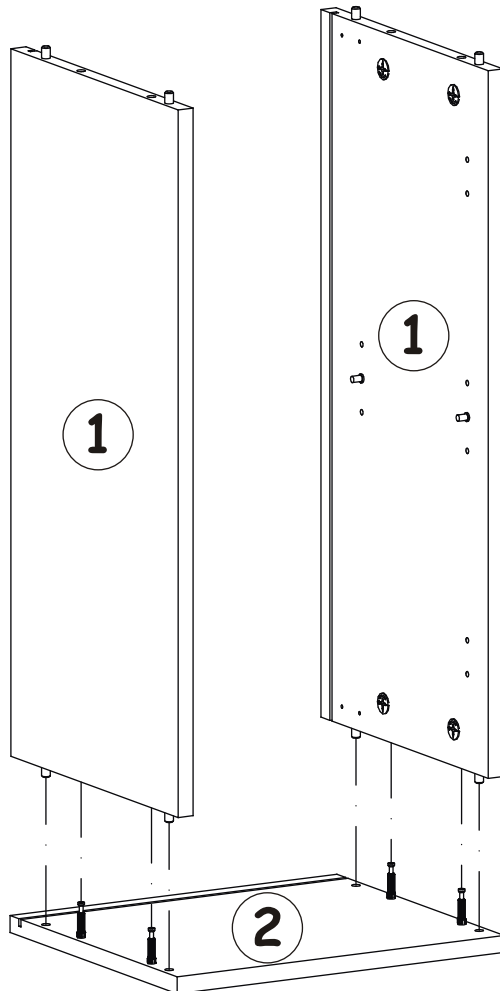

G5	
x4	

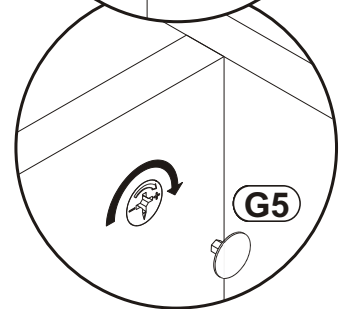
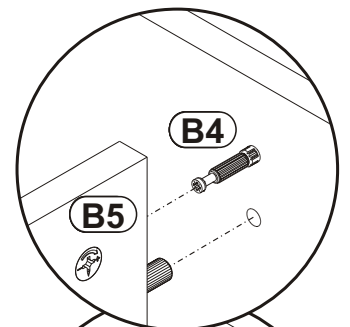

5

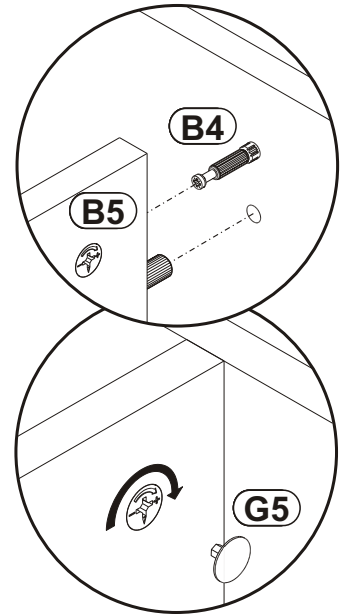
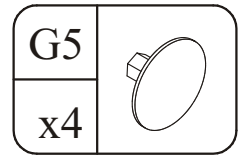
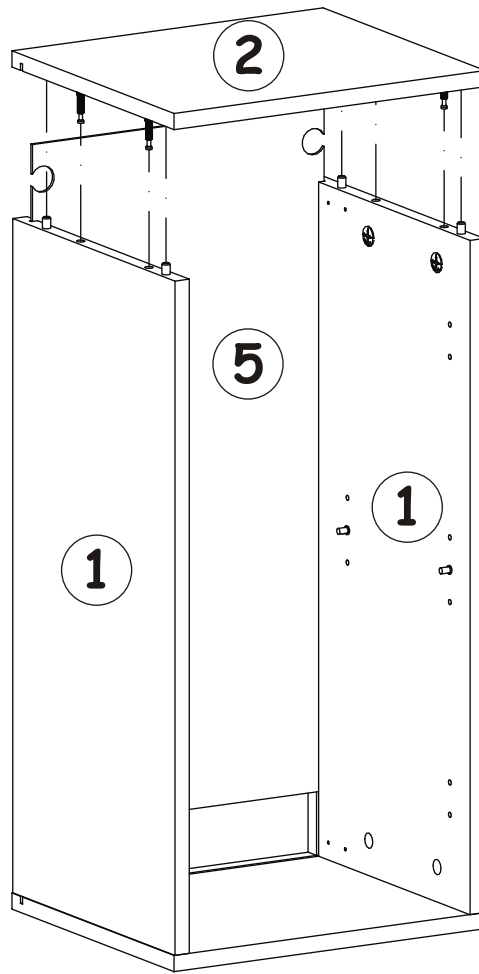

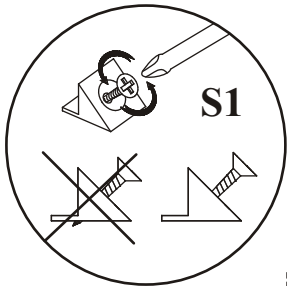
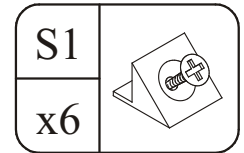

6

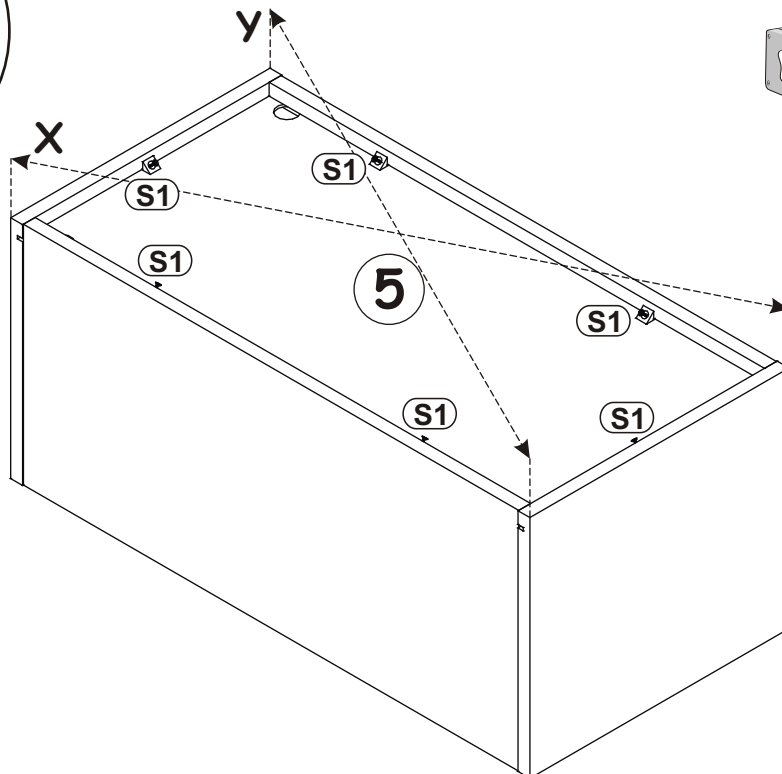

$X=Y$   $\uparrow$   $90^\circ$

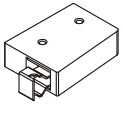

7

ZR1		D6	
x2		x4	

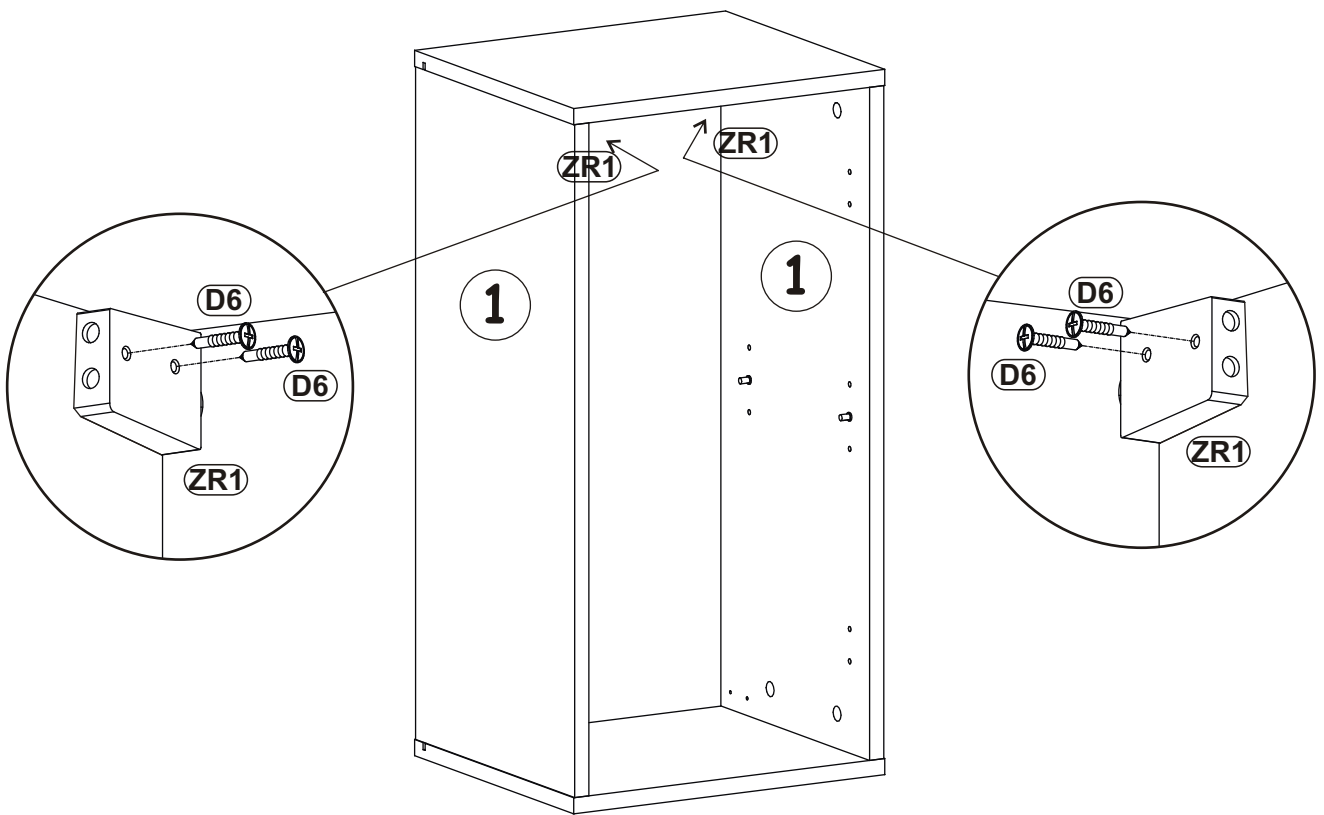

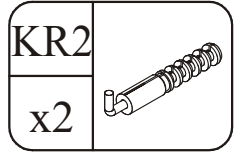

8

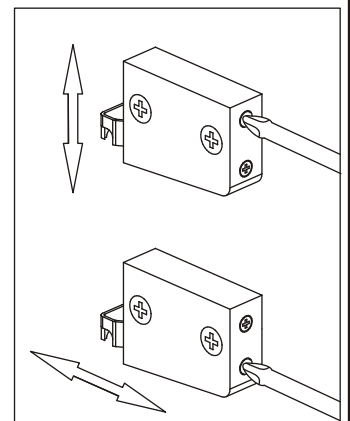
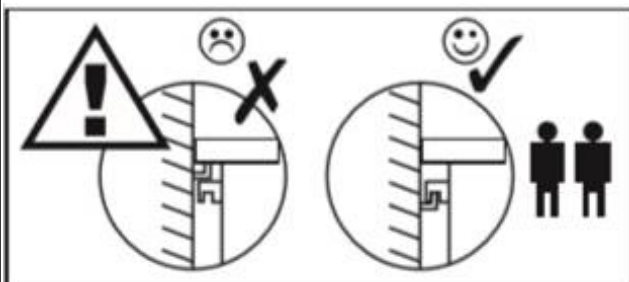
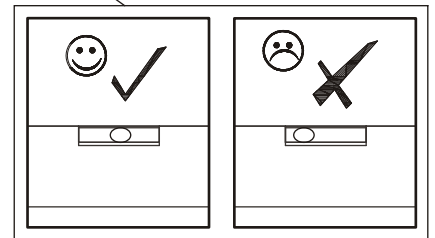
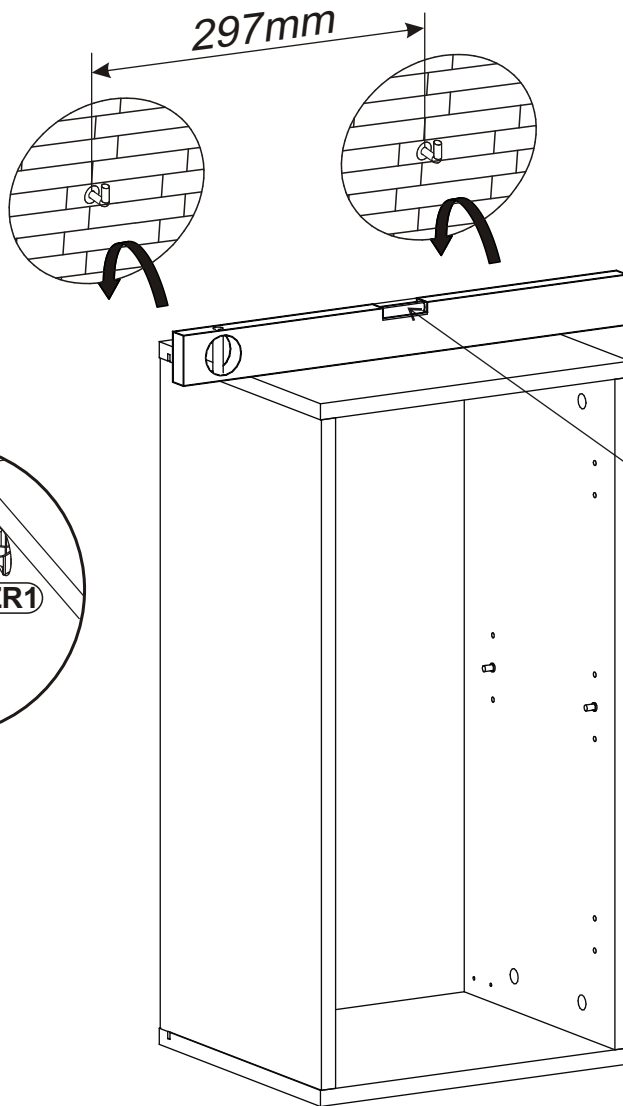
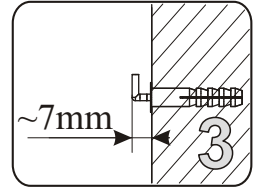
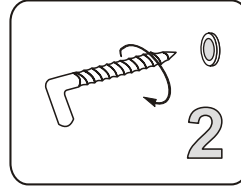
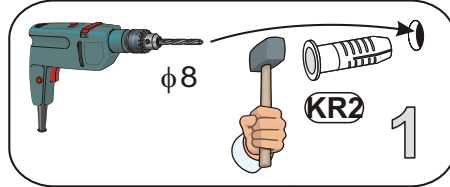
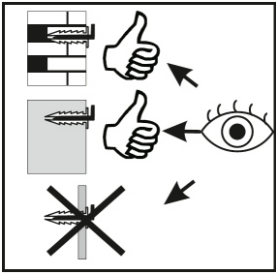

9 - 10

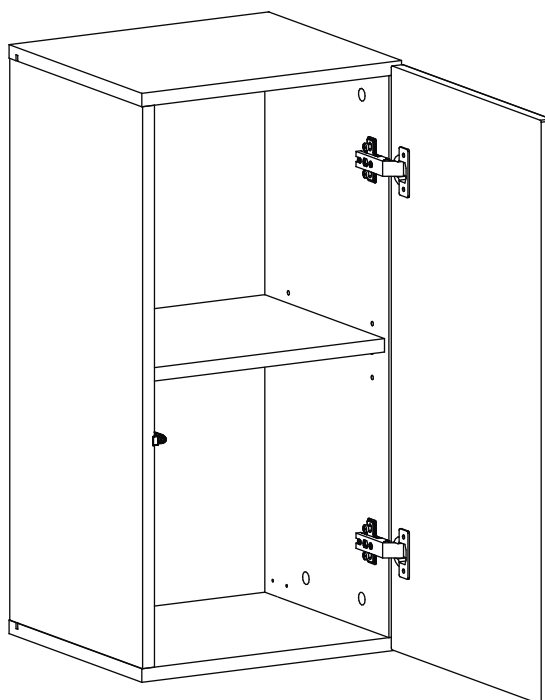

11 - 12

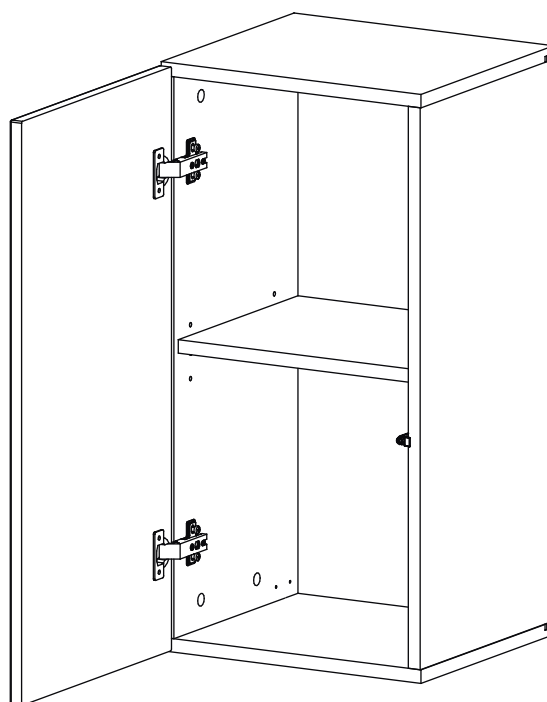



BLOX TYP 25

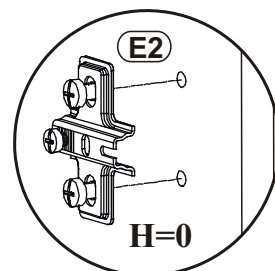
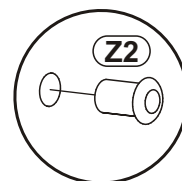
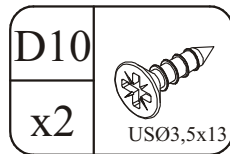
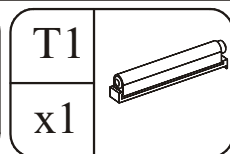
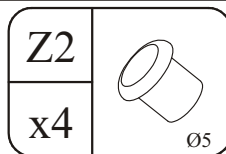
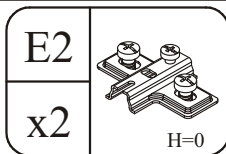
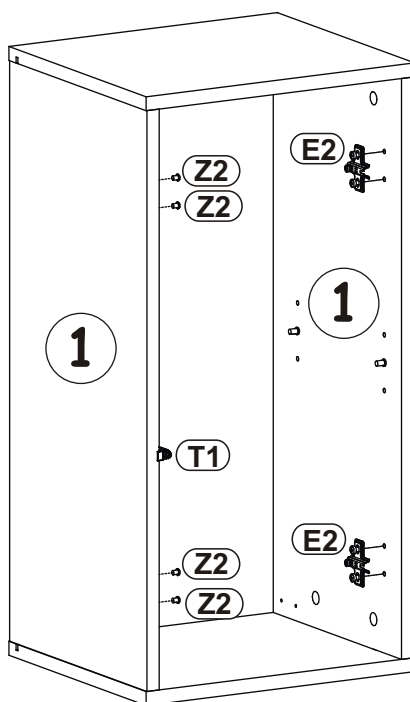
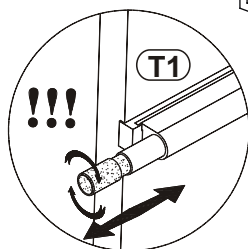
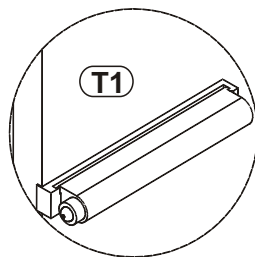
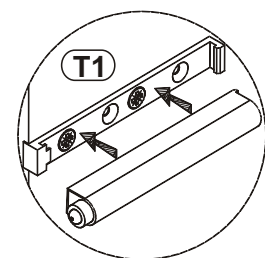
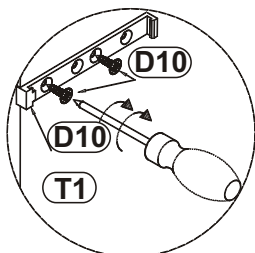
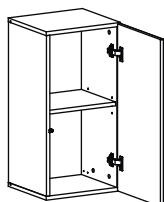

9

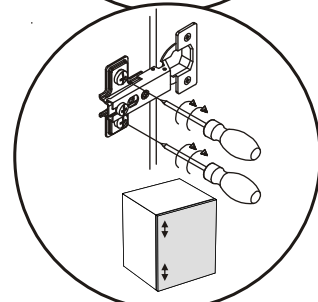
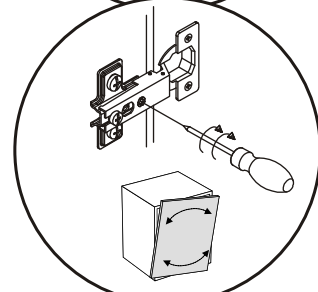
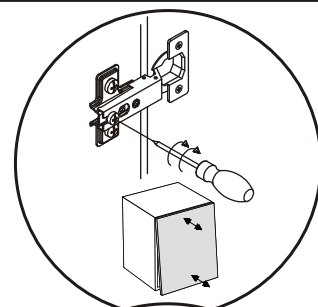
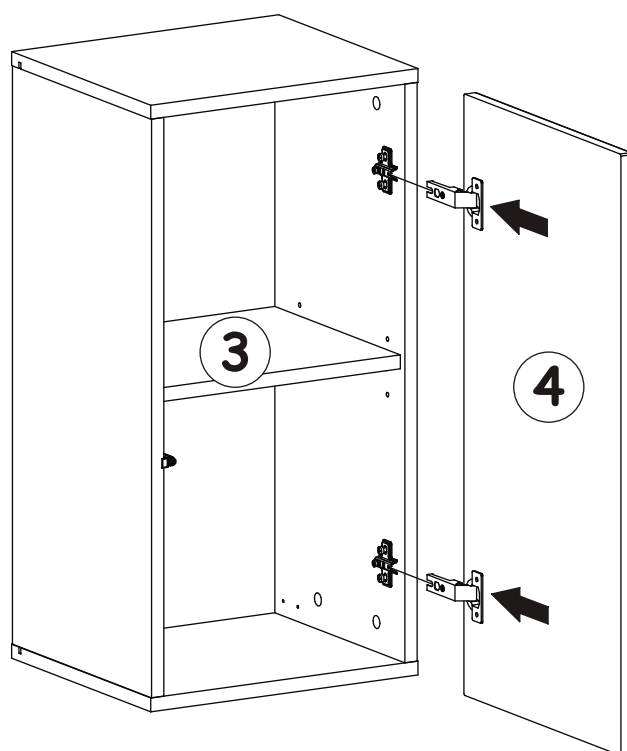

10

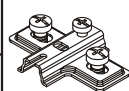

BLOX TYP 25

E2		Z2		T1	
x2	H=0	x4	Ø5	x1	

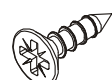
D10	
x2	USØ3,5x13

11

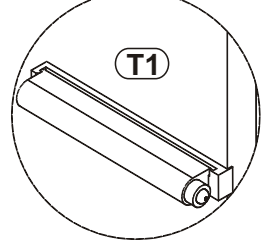
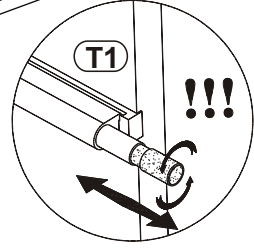
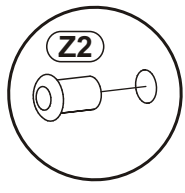
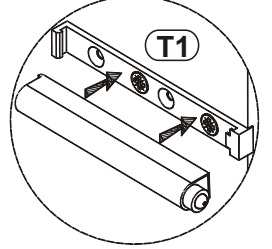
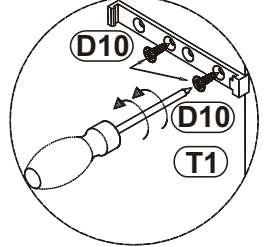
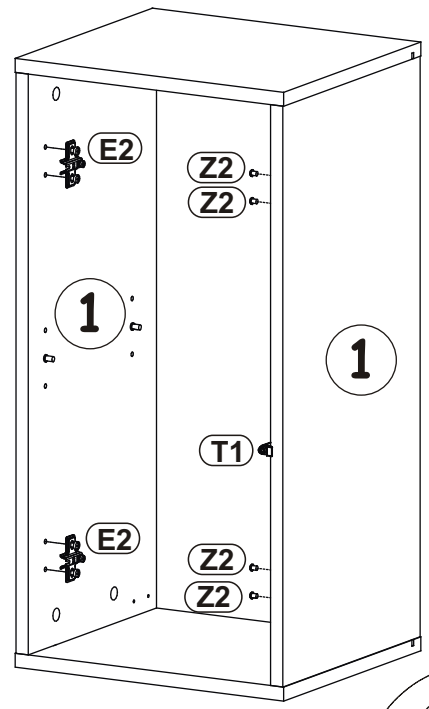
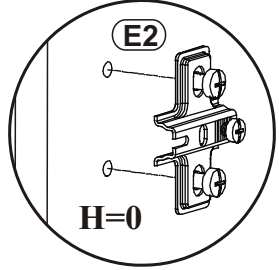
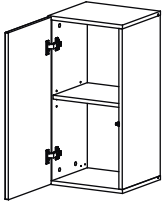

12

