

BLOX TYP 27

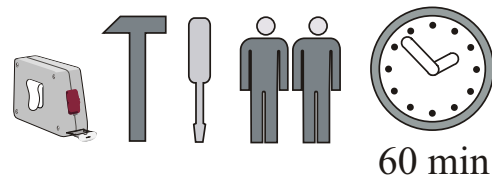
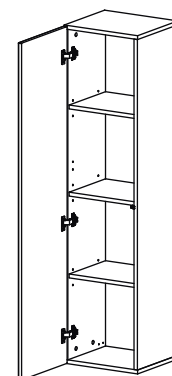
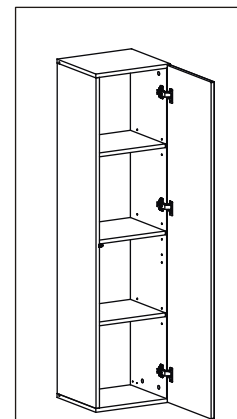
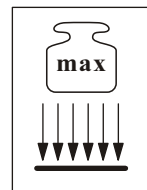
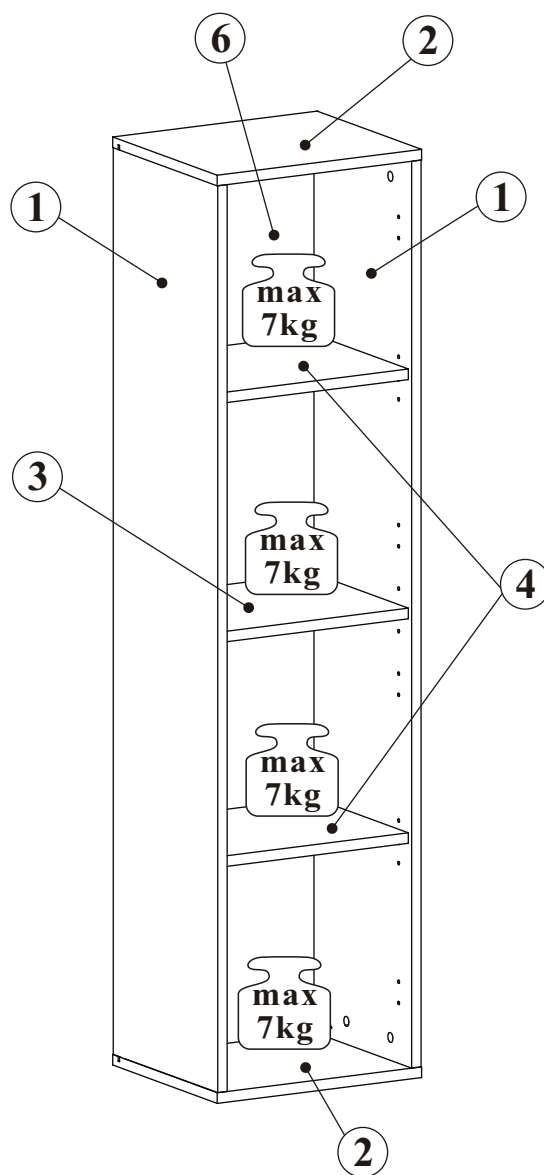
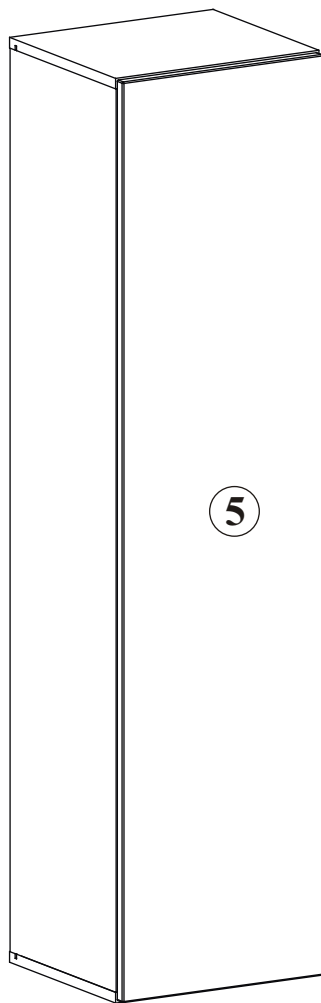

NO	Dim.		Col.-No	Qty
1	1367	304	1	2
2	349	304	1	2
3	315	274	1	1
4	315	274	1	2
5	343	1393	1	1
6	1379	327	1	1

BLOX TYP 27

A1 x8 ø8x36	B4 x12	B5 x12 Ø15x12	G5 x12	ZR1 x2	D6 x4 USØ3,5x30
E21 x3 Ø35 H=0	E2 x3 H=0	D10 x8 USØ3,5x13	Z2 x10 Ø5	T1 x1	G7 x8
S1 x10	UP13 x2 UPØ3x16	KR2 x2	G2 x1		

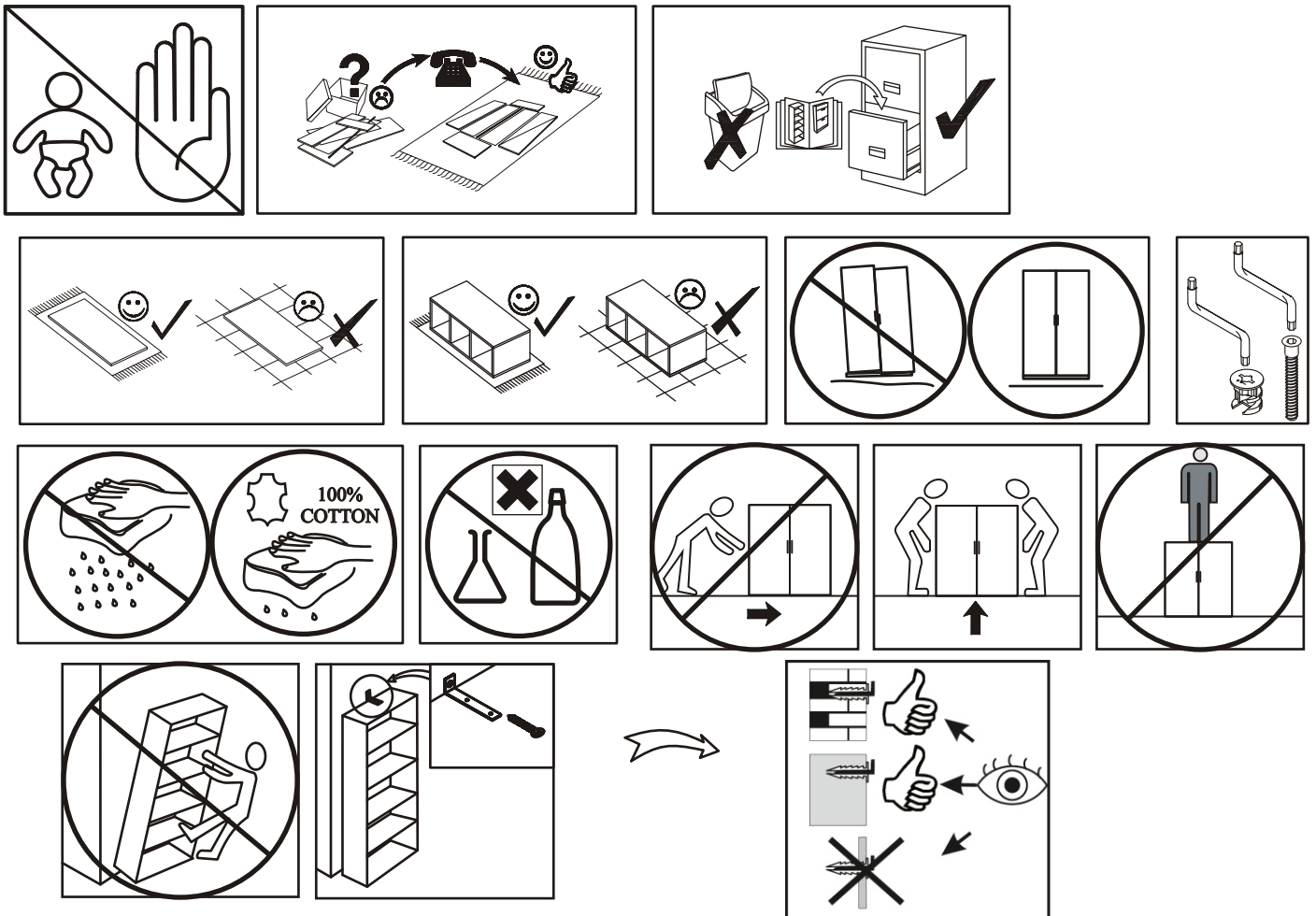
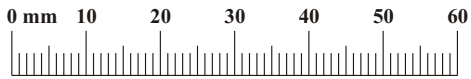

BLOX TYP 27

A1	
x8	∅8x36

B5	
x8	∅15x12

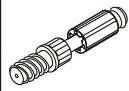
B4	
x4	

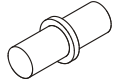
G7	
x8	

1

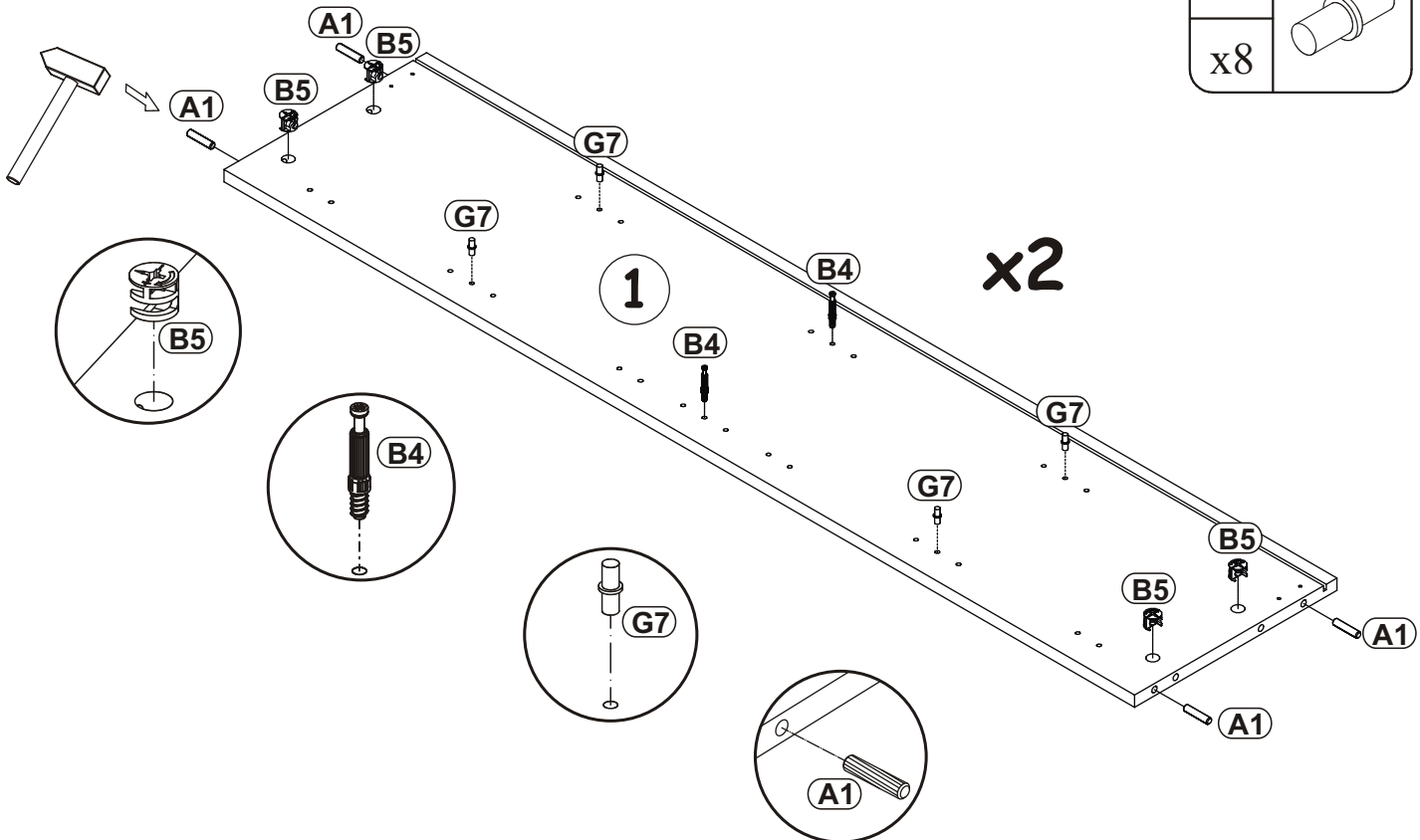

2

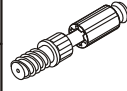
B4	
x8	

B5	
x4	∅15x12

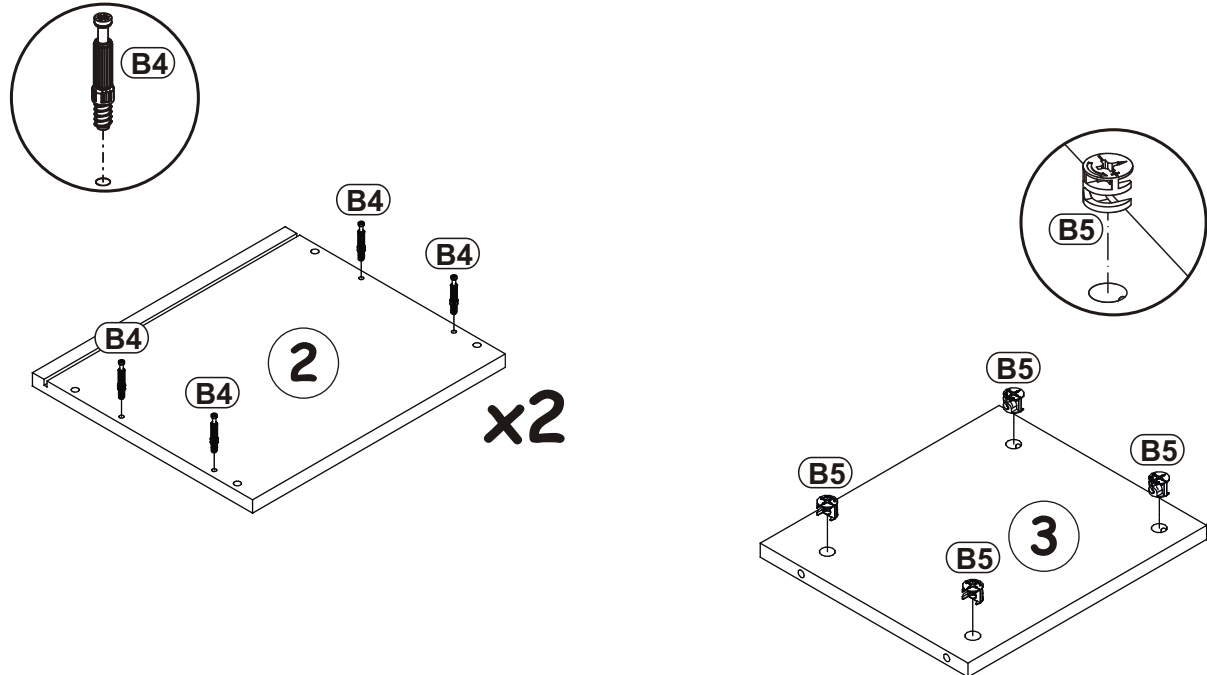

BLOX TYP 27

3

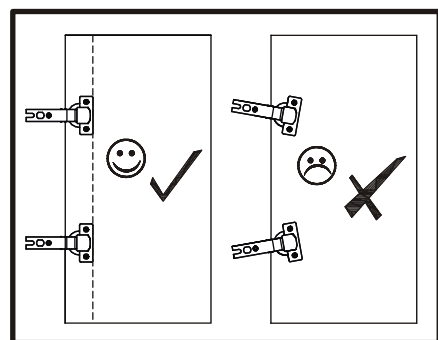
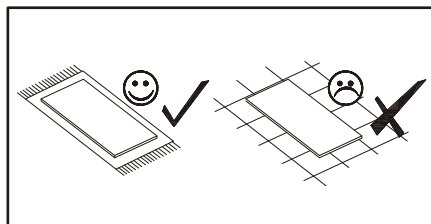

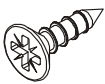
E21	Ø35	D10	 USØ3,5x13
x3	H=0	x6	

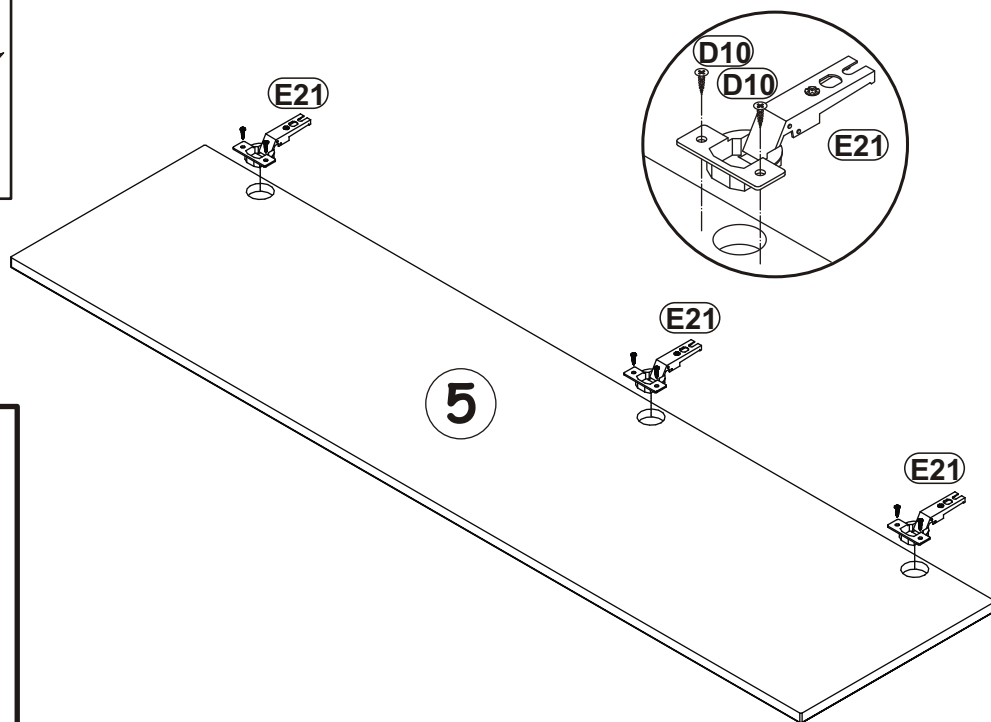

4

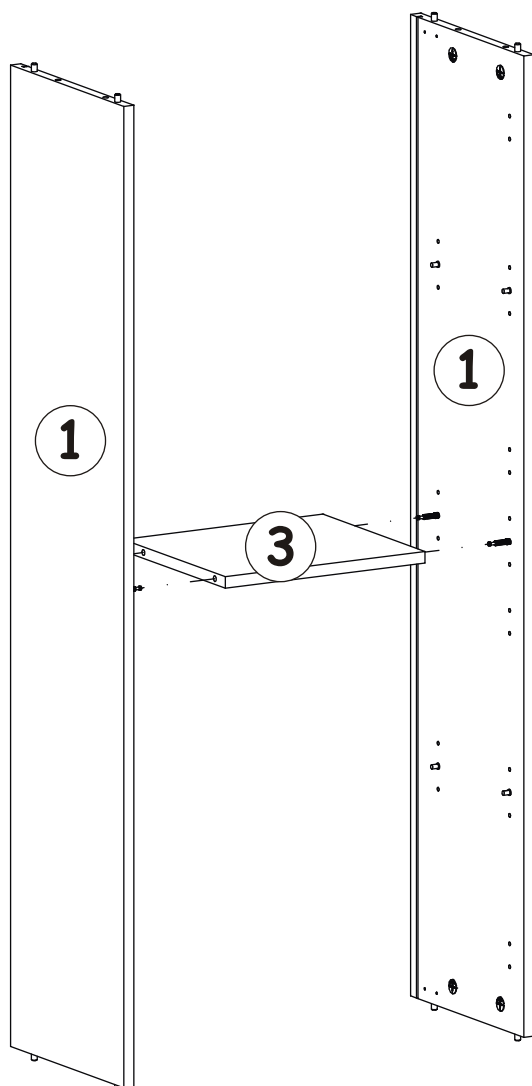

G5	
x4	

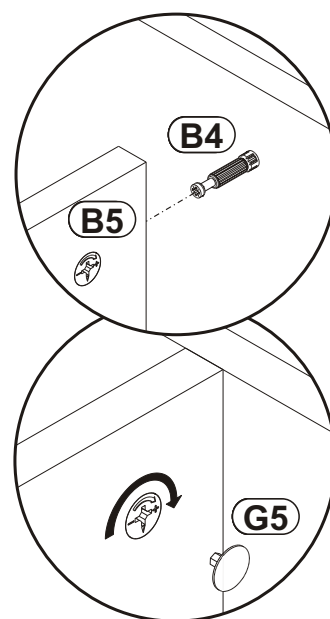

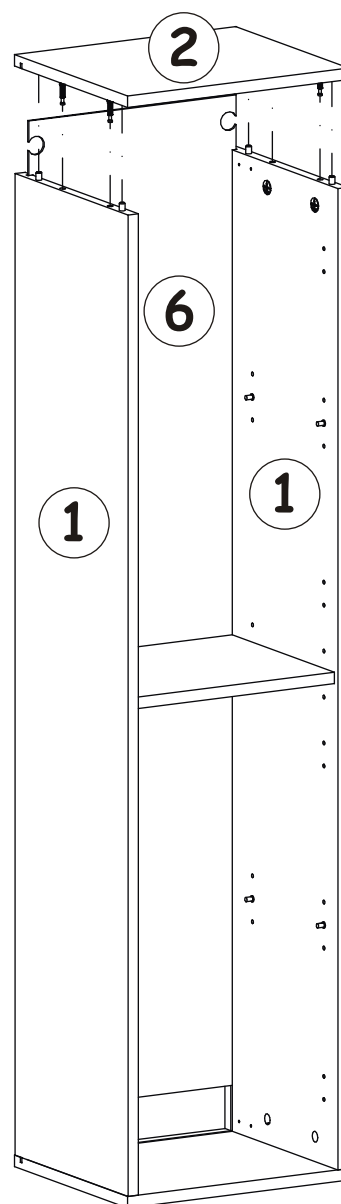
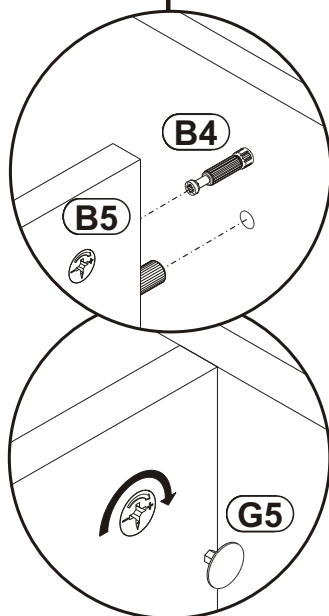
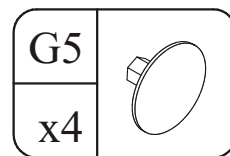
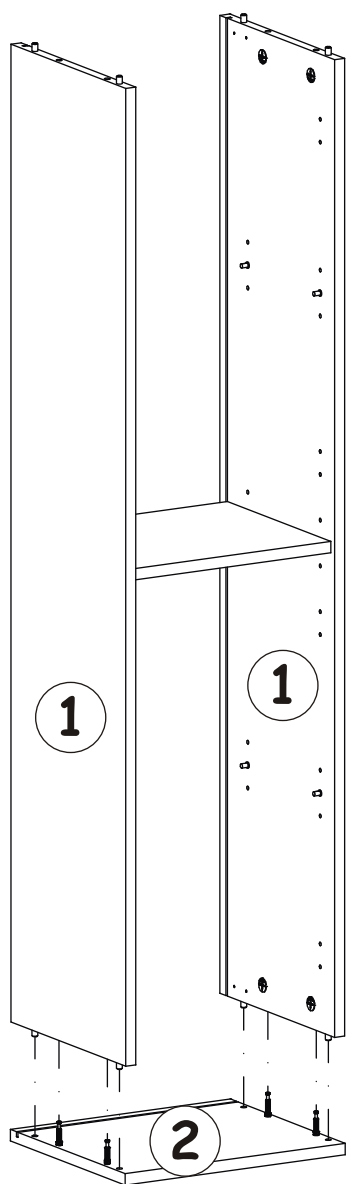
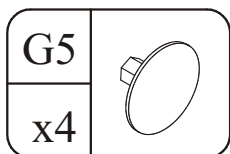

5

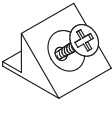

BLOX TYP 27

7

S1		UP13	
x10		x2	UPØ3x16

 $X=Y$ 90°

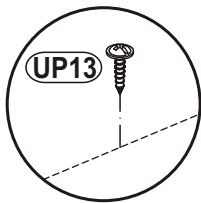
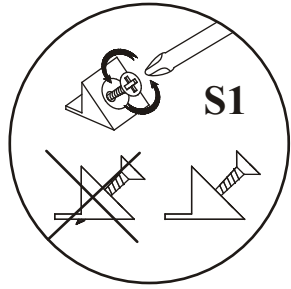
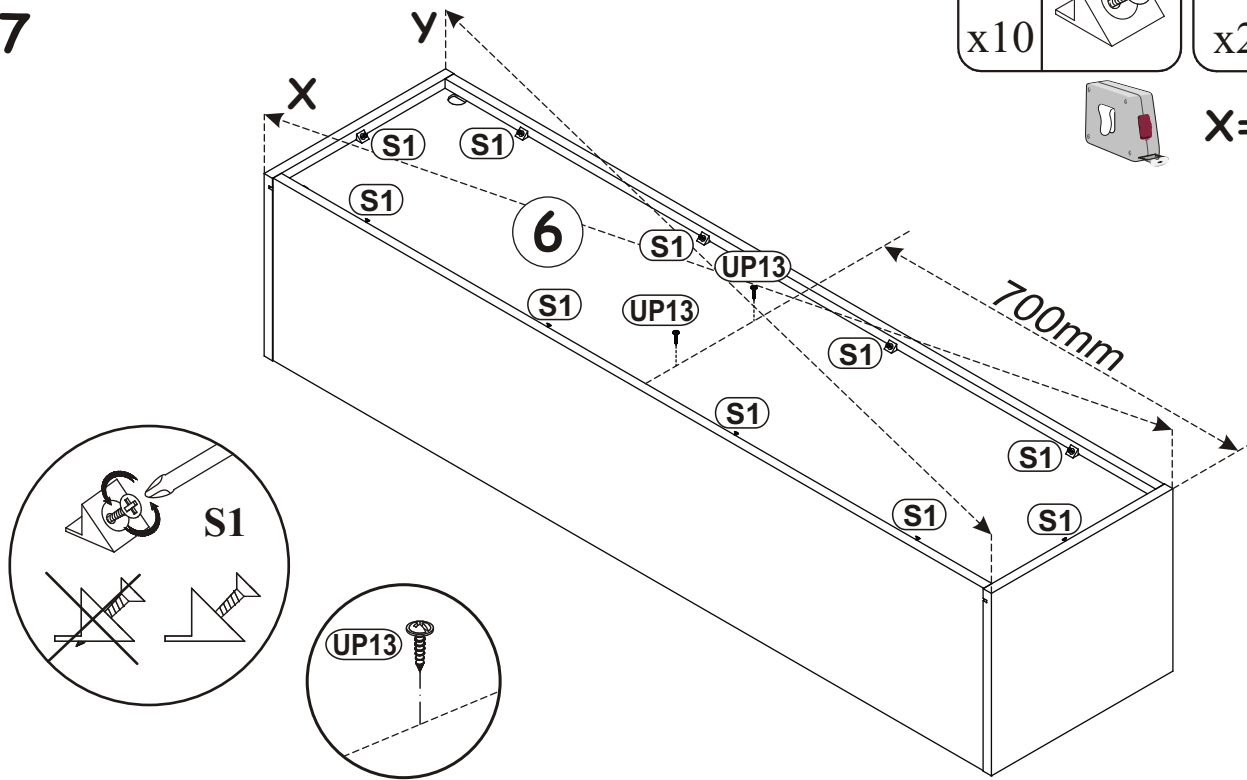

8

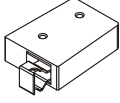
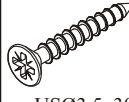
ZR1		D6	
x2		x4	USØ3,5x30

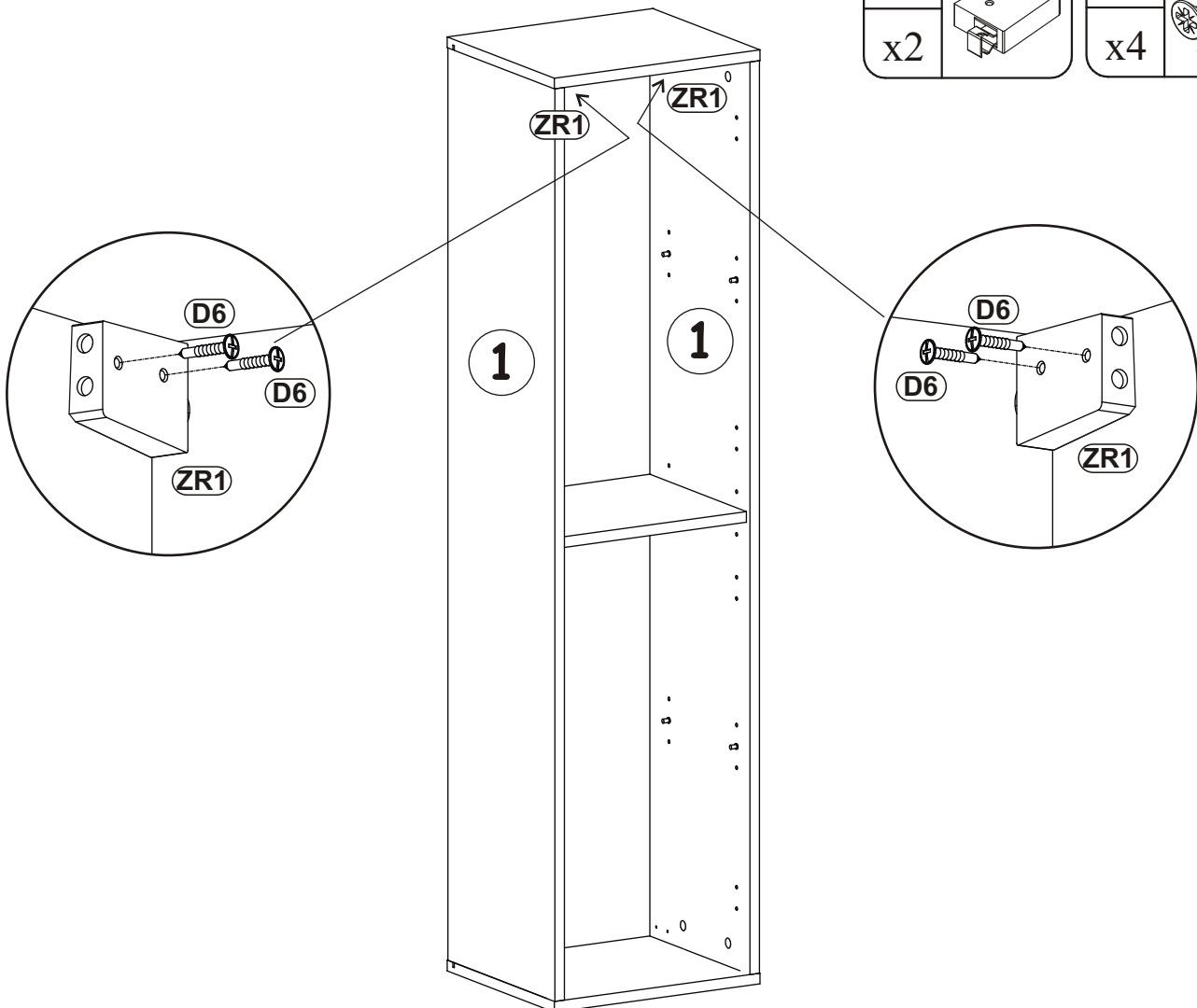

KR2

x2

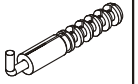

9

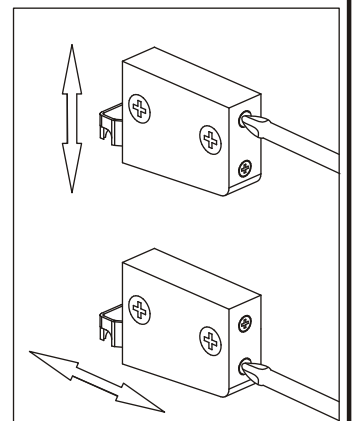
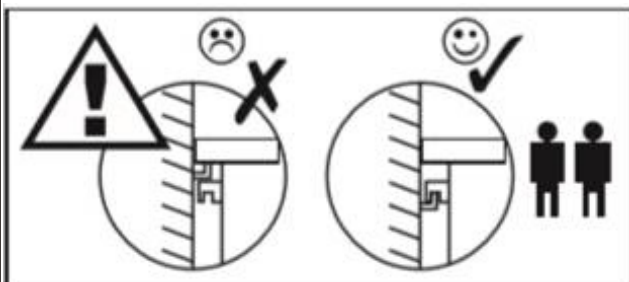
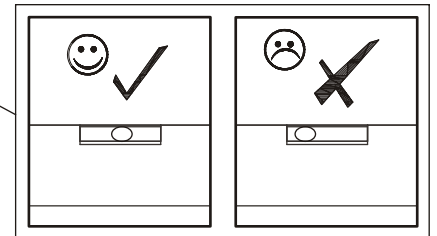
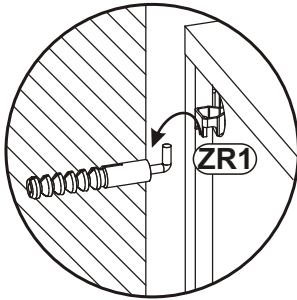
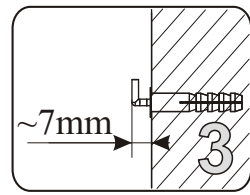
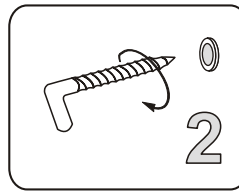
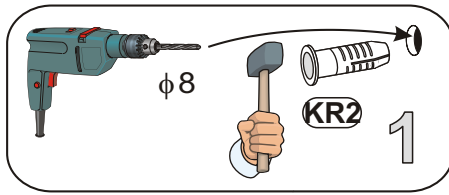
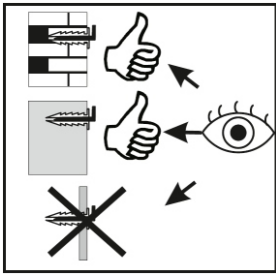

10 - 11

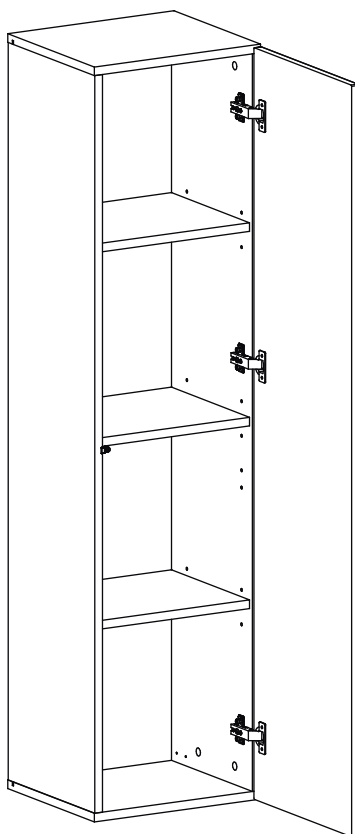

12 - 13

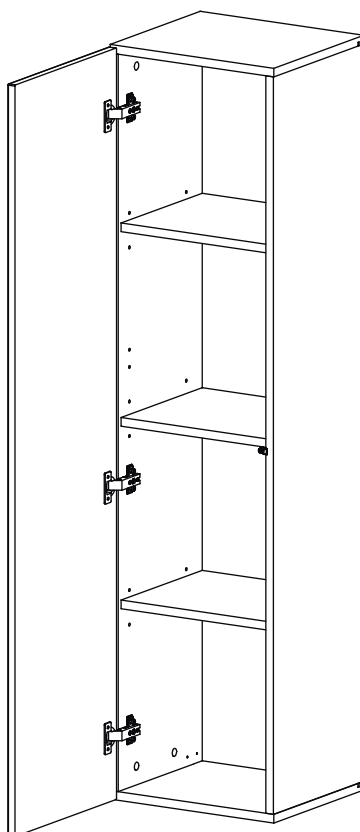

10

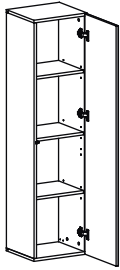

E2		Z2	
x3	H=0	x10	Ø5
T1		D10	
x1		x2	USØ3,5x13

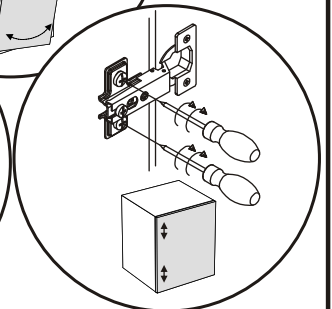
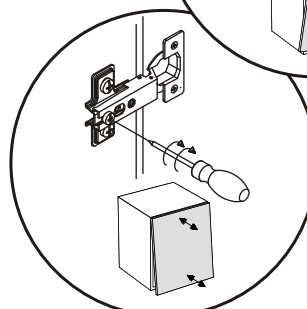
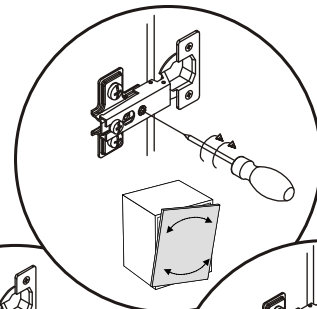
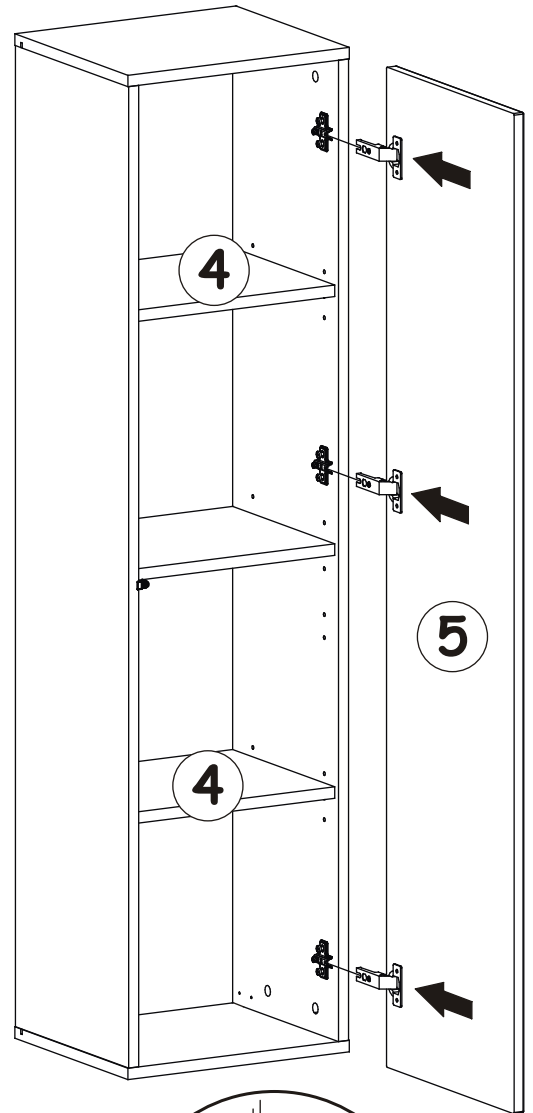
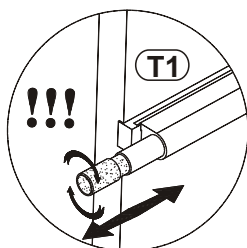
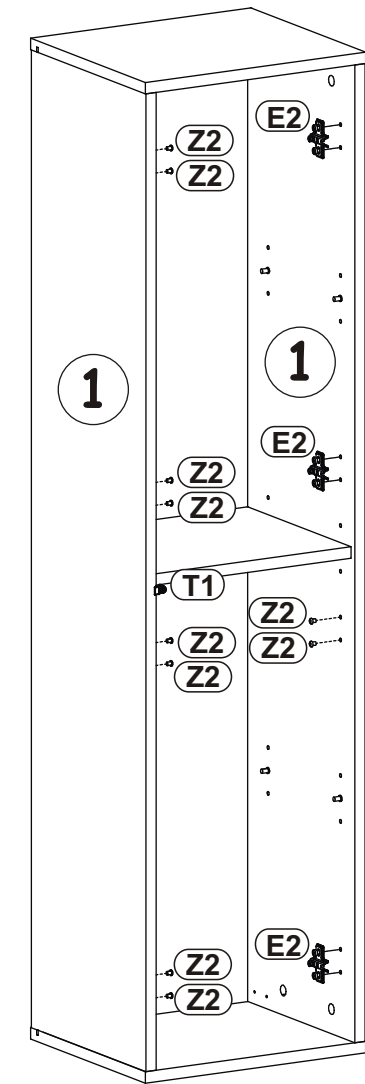
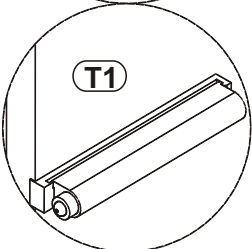
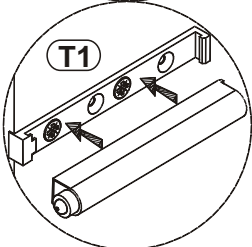
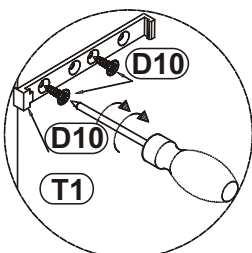
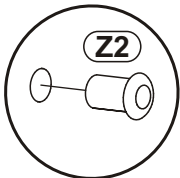
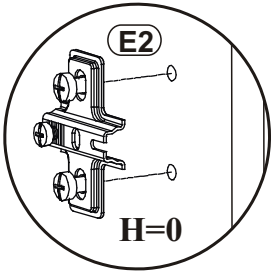

12

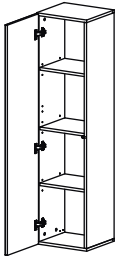

E2		Z2	
x3	H=0	x10	Ø5
T1		D10	
x1		x2	USØ3,5x13

