

# BLOX TYP 26

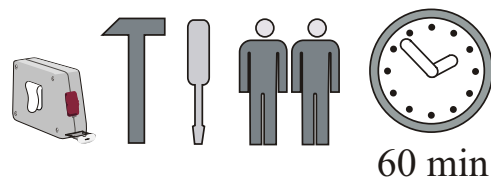
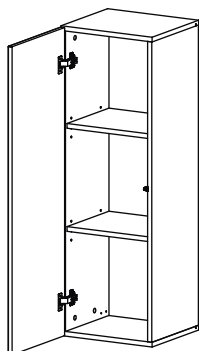
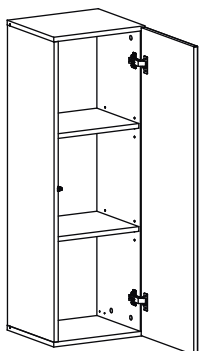
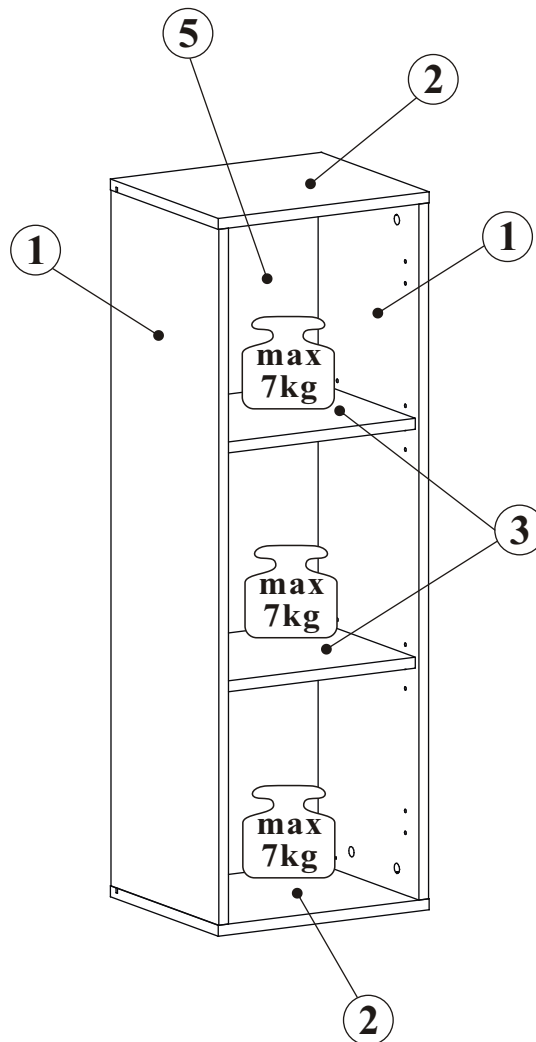
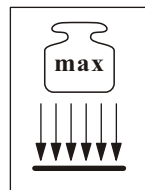
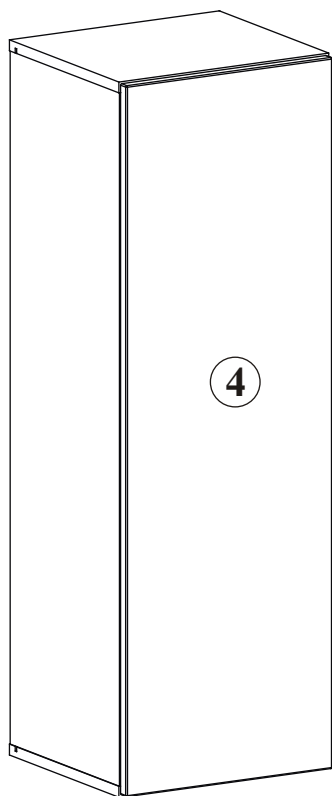

NO	Dim.		Col.-No	Qty
1	1017	304	1	2
2	349	304	1	2
3	315	274	1	2
4	343	1043	1	1
5	1029	327	1	1

# BLOX TYP 26

A1 x8 ø8x36	B4 x8	B5 x8 Ø15x12	G5 x8	ZR1 x2	D6 x4 USØ3,5x30
E21 x2 Ø35 H=0	E2 x2 H=0	D10 x6 USØ3,5x13	Z2 x4 Ø5	T1 x1	G7 x8
S1 x8	KR2 x2	G2 x1			

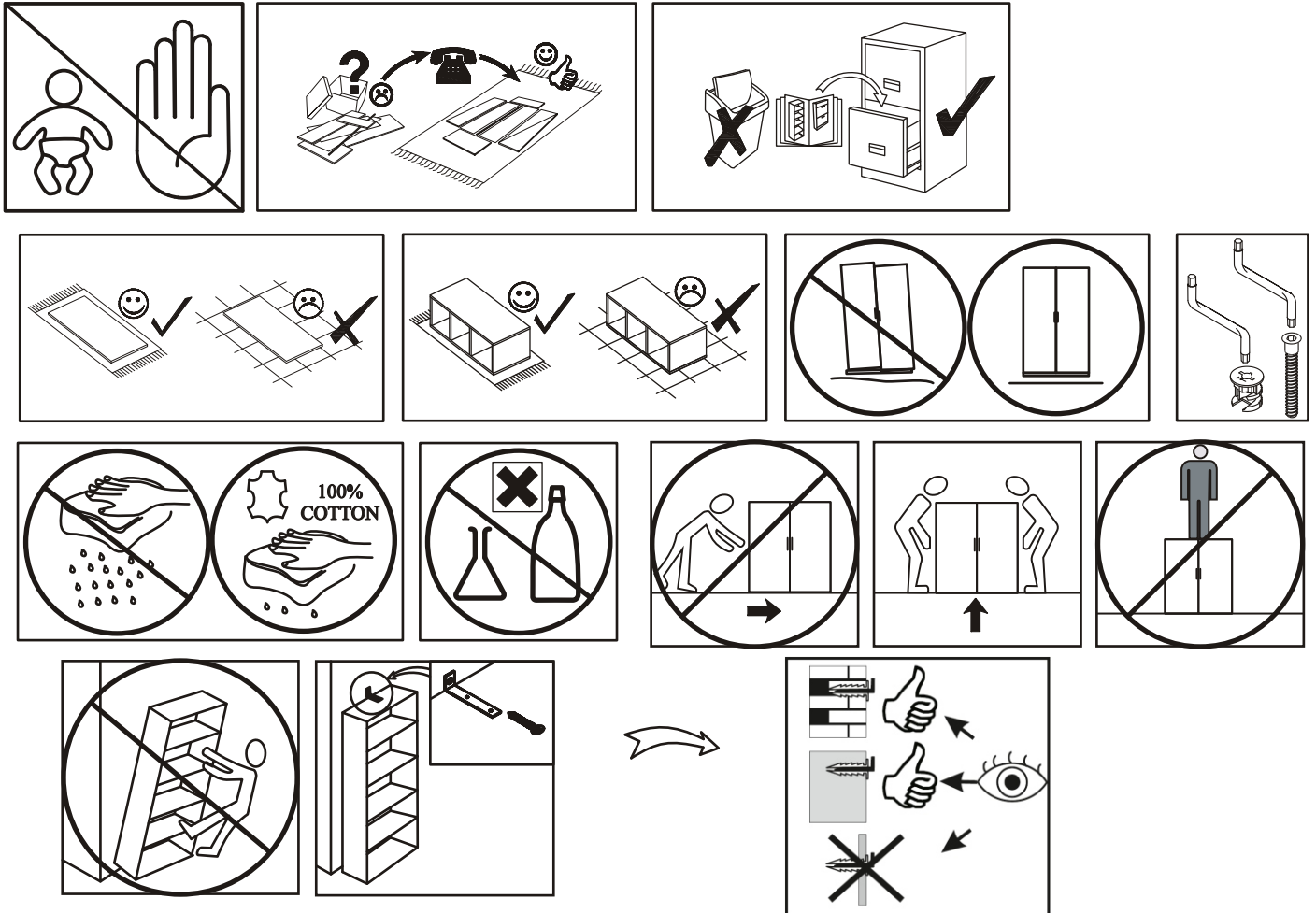
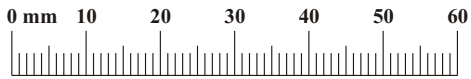

BLOX TYP 26

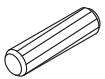
A1	
x8	ø8x36

B5	
x8	Ø15x12

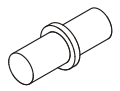
G7	
x8	

1

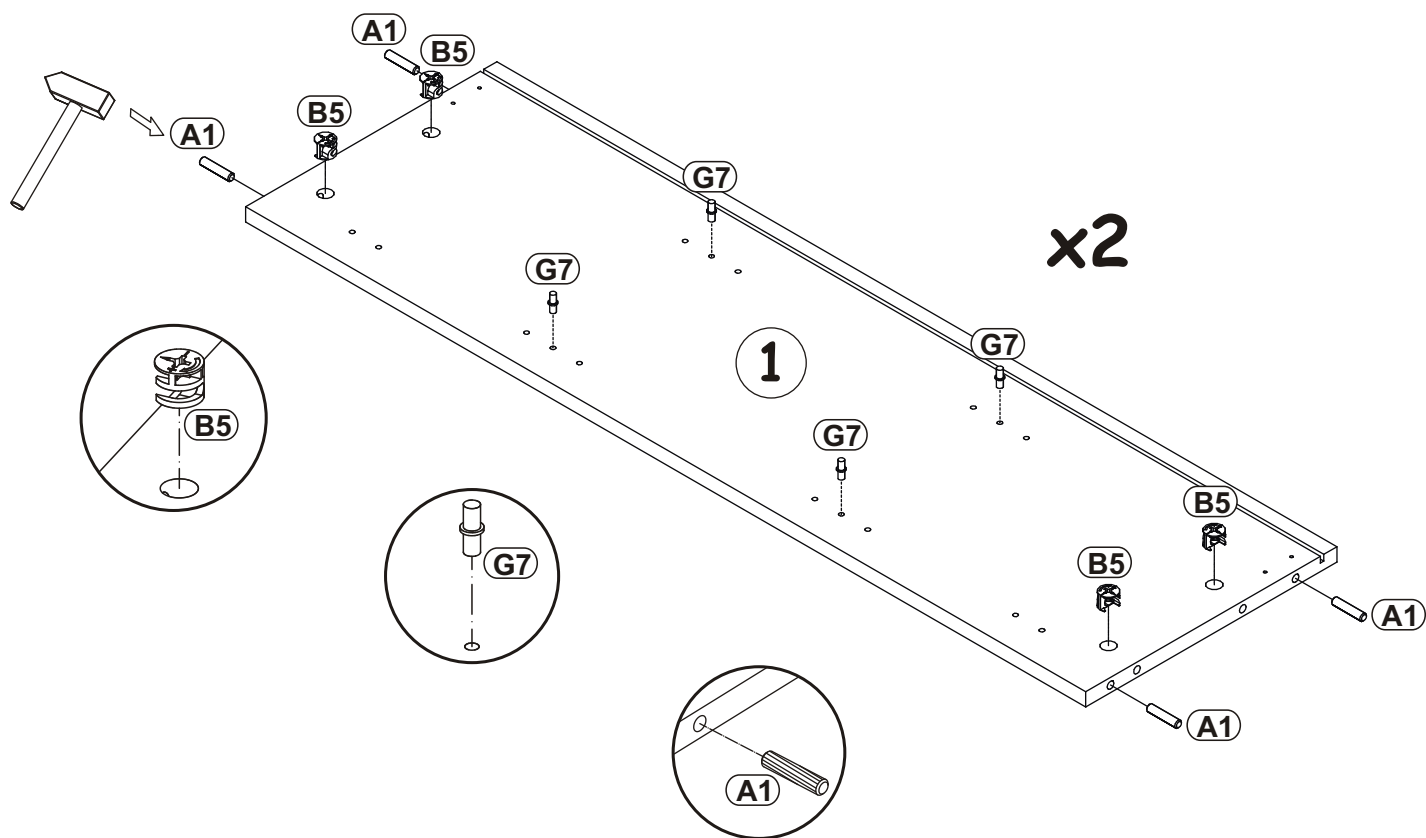

2

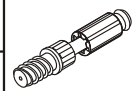
B4	
x8	

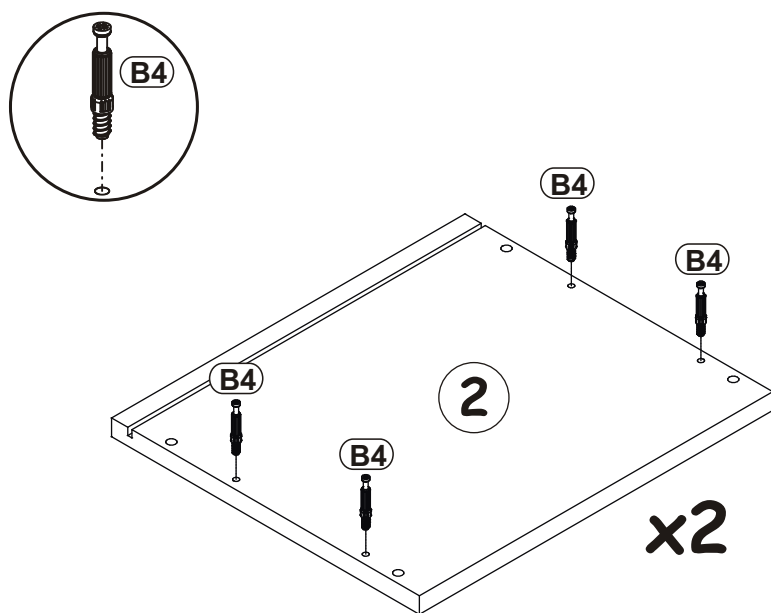

BLOX TYP 26

3

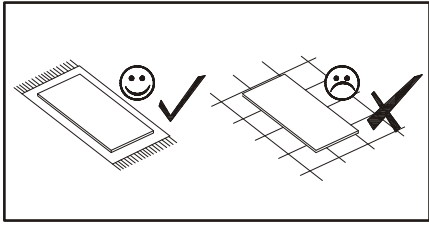

E21	Ø35	D10	 USØ3,5x13
x2	H=0	x4	

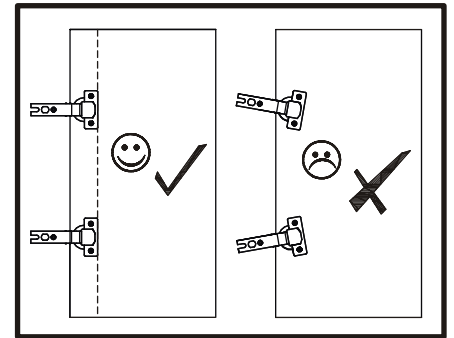
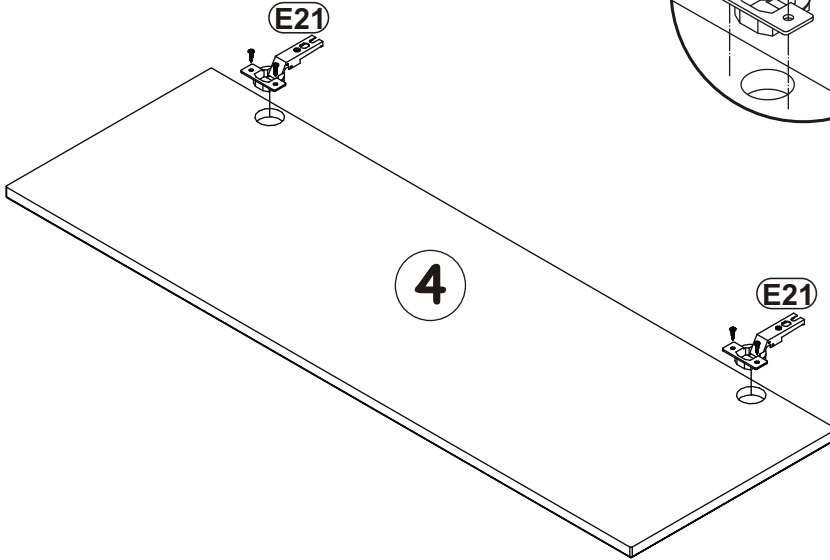

4

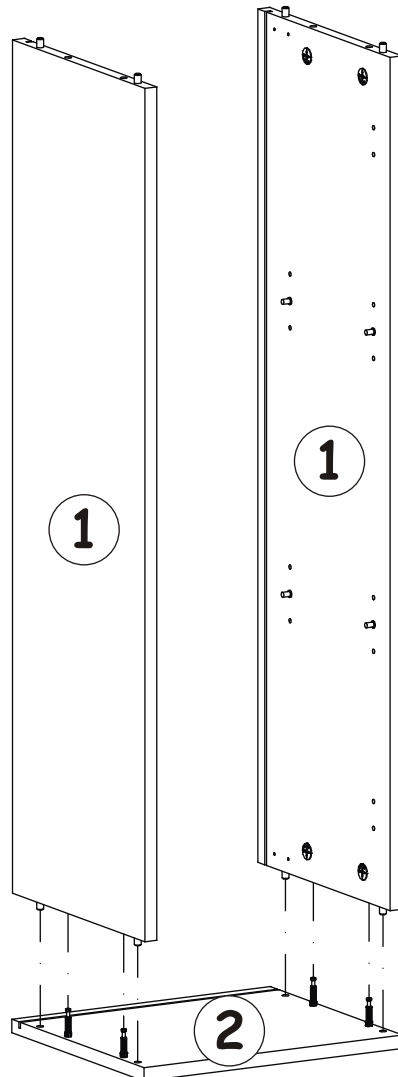

G5	
x4	

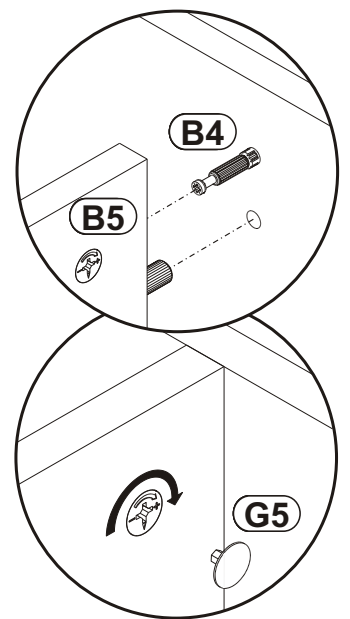

5

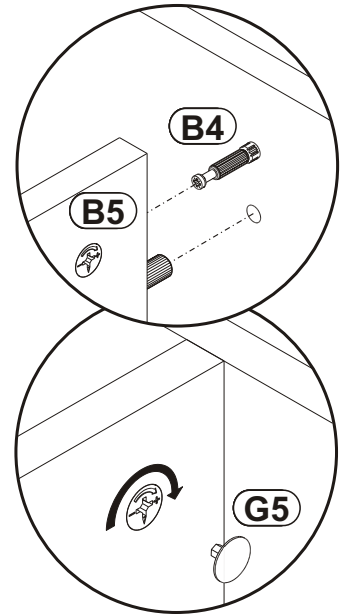
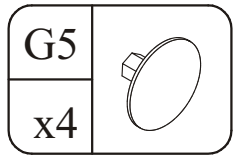
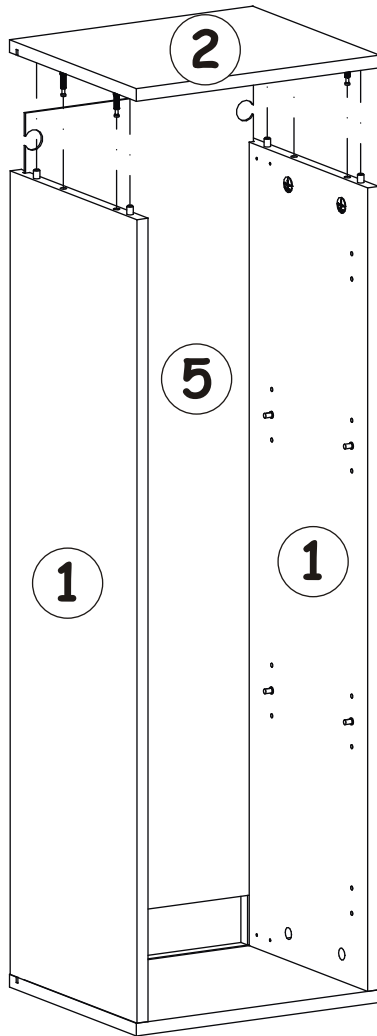

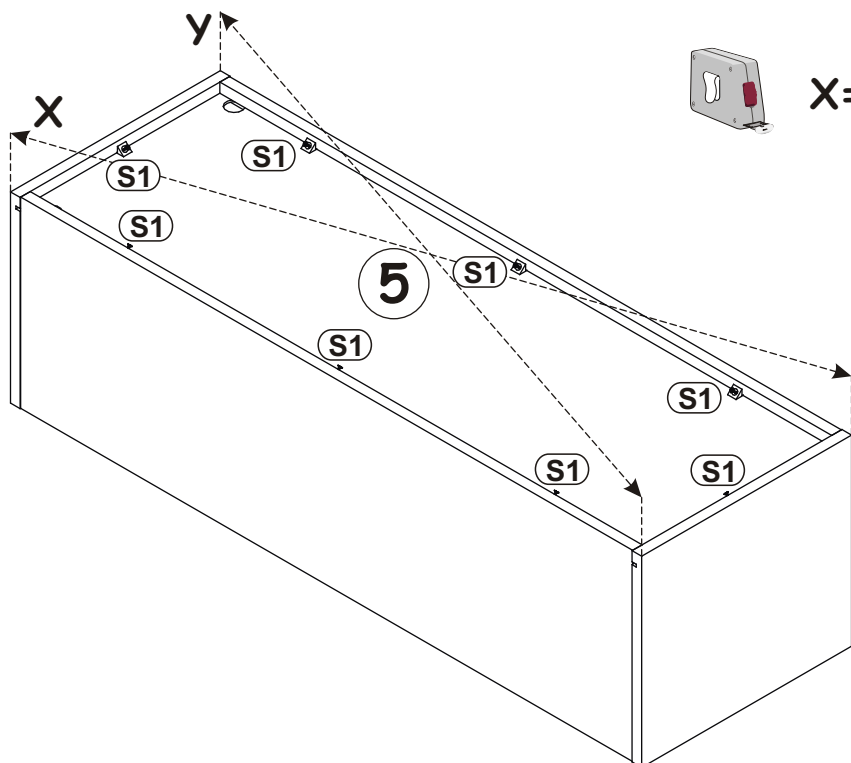
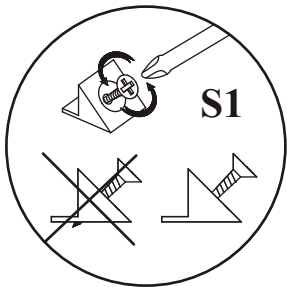
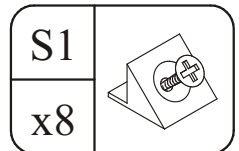

6

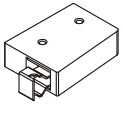

X=Y  $\uparrow$  90°

7

ZR1		D6	
x2		x4	USØ3,5x30

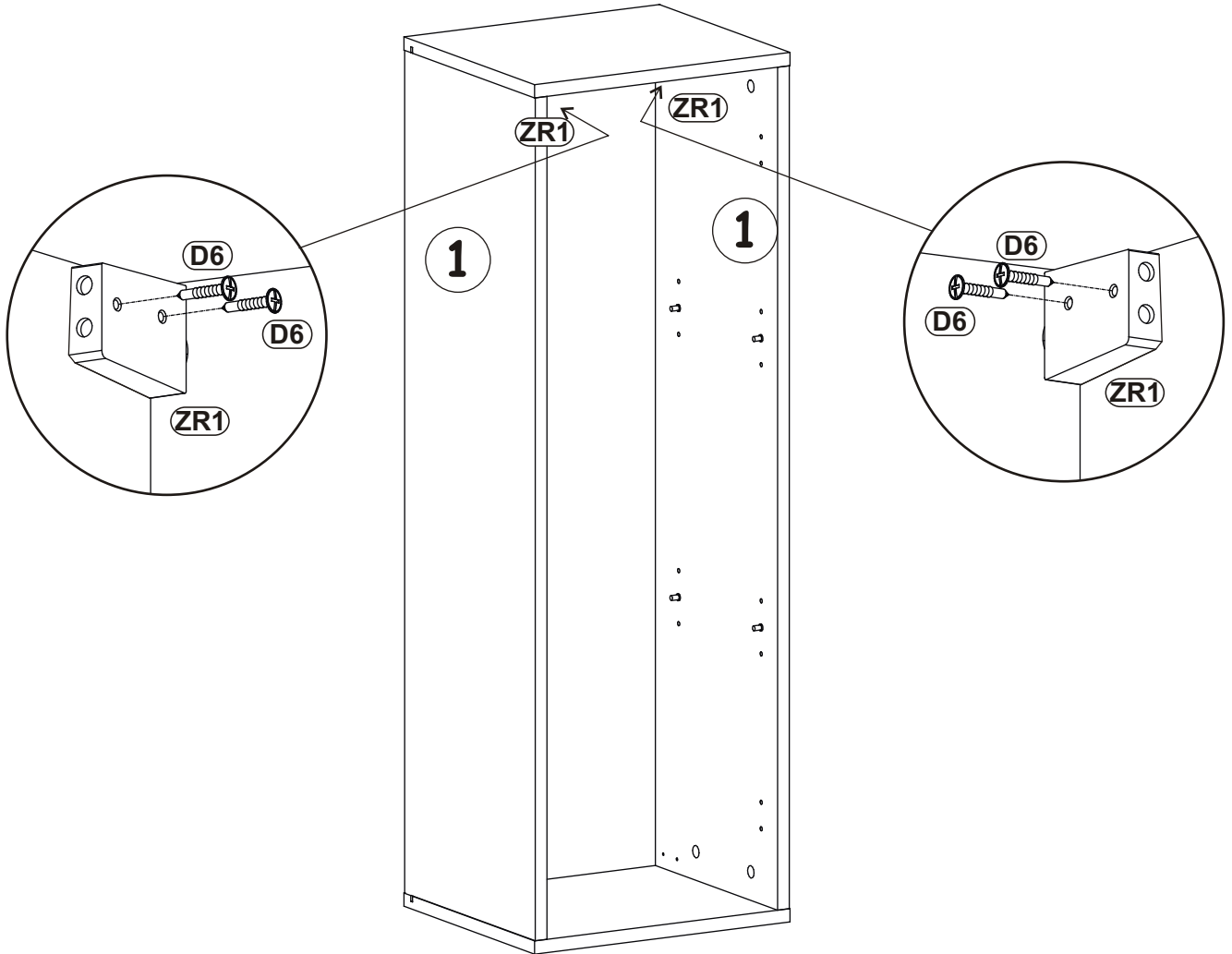

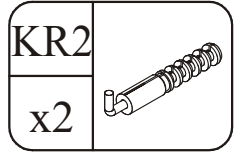

8

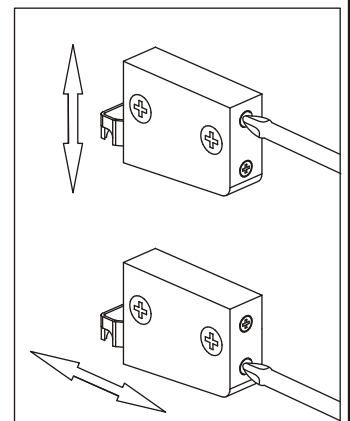
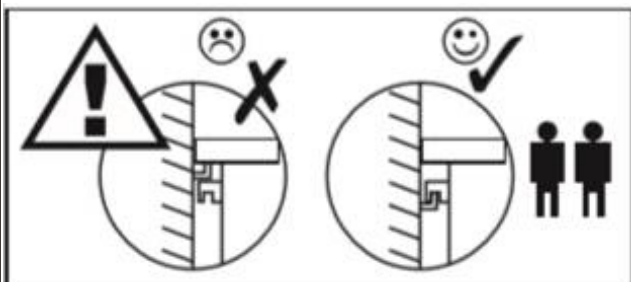
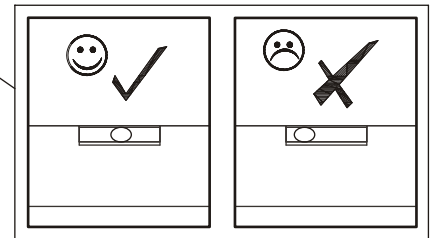
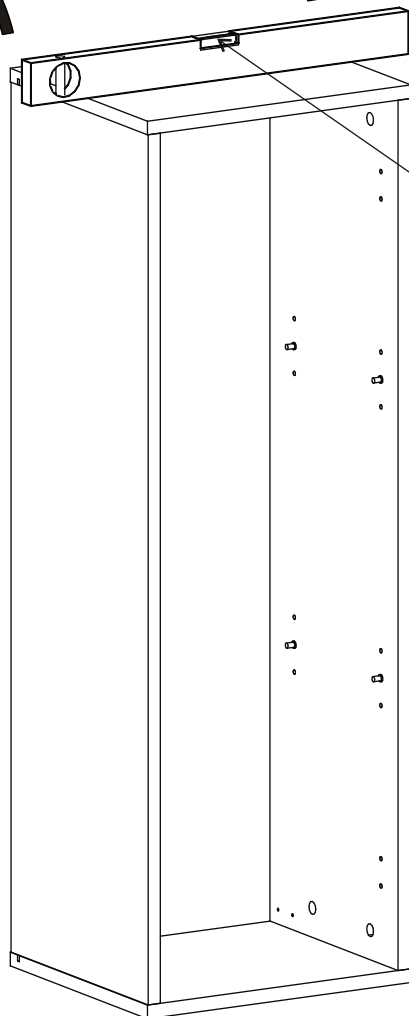
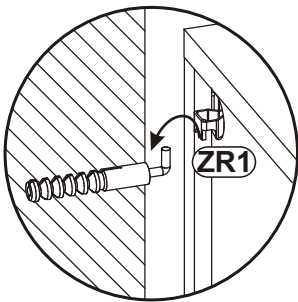
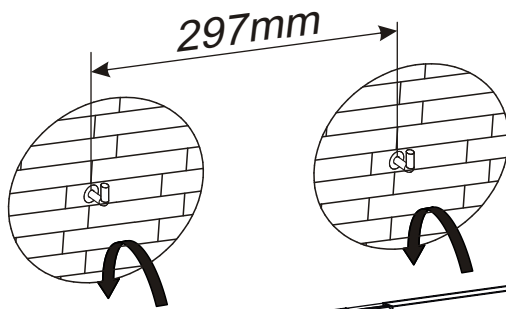
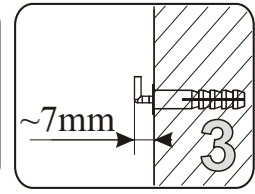
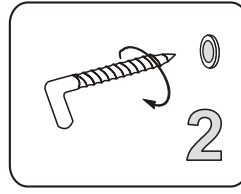
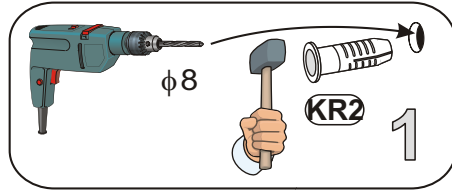
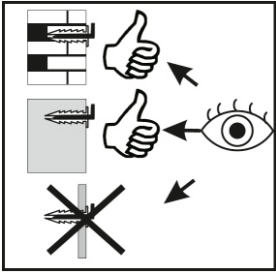

9 - 10

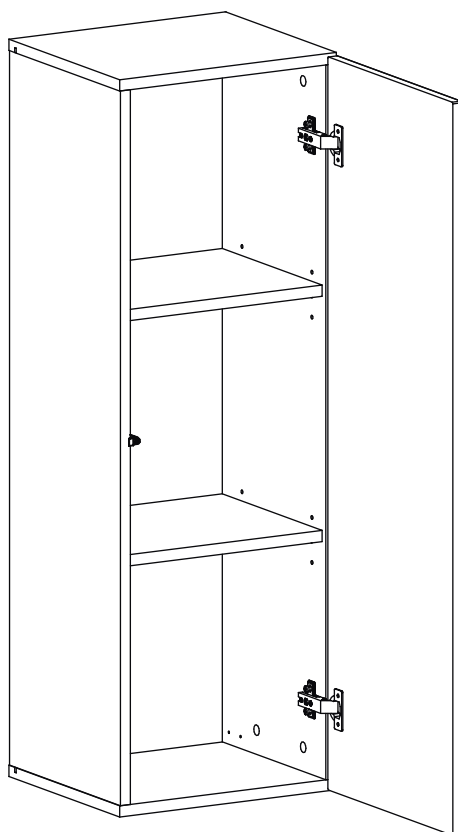

11 - 12

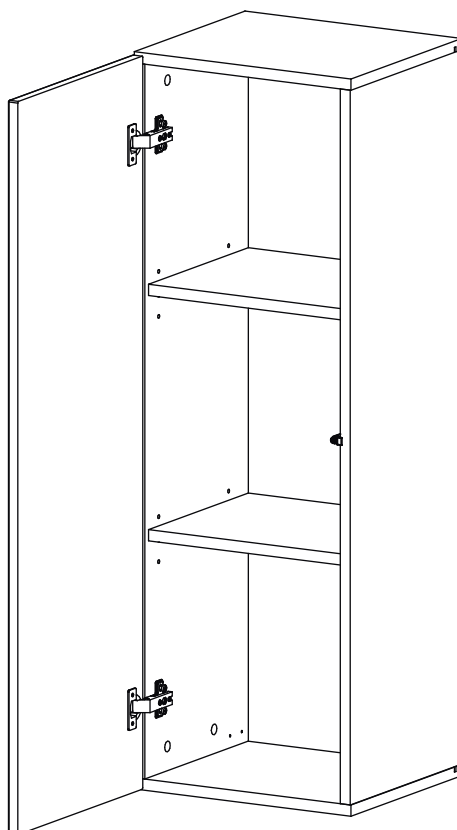



BLOX TYP 26

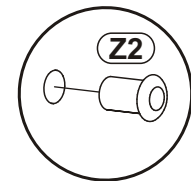
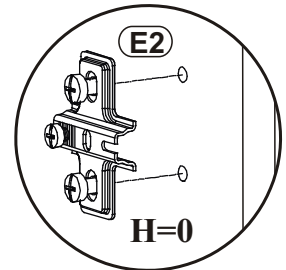
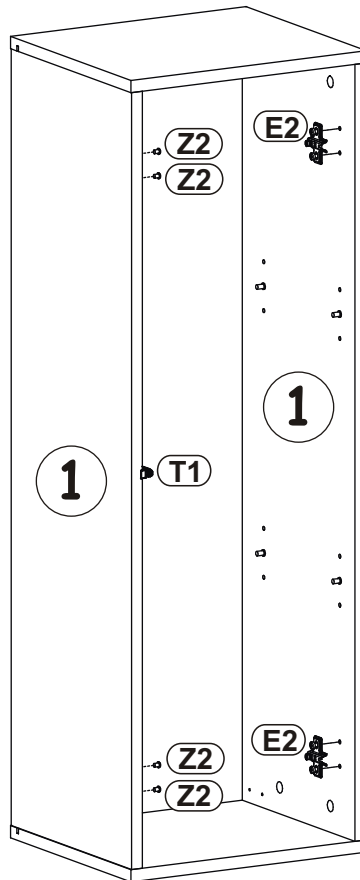
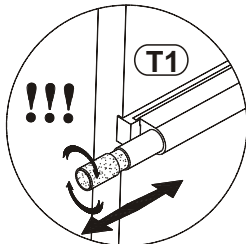
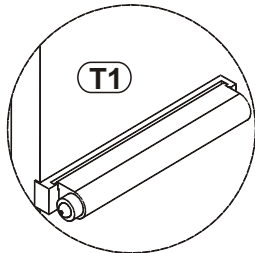
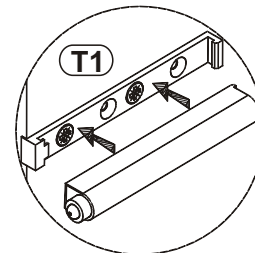
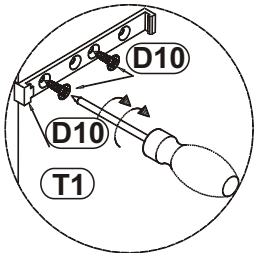
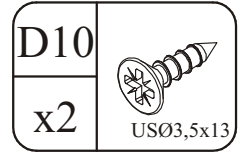
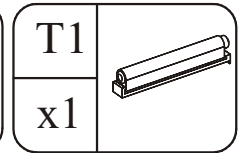
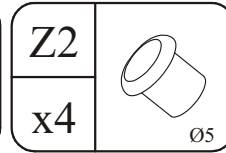
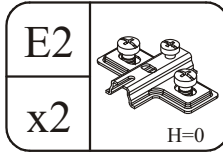
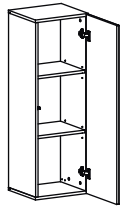

9

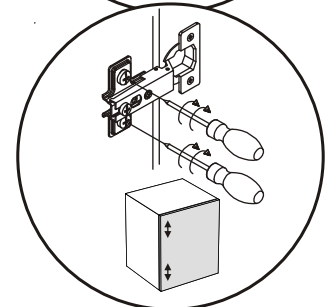
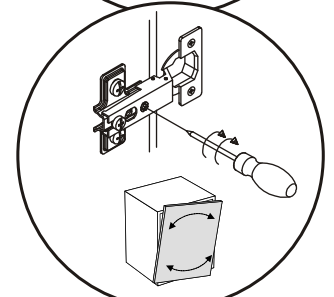
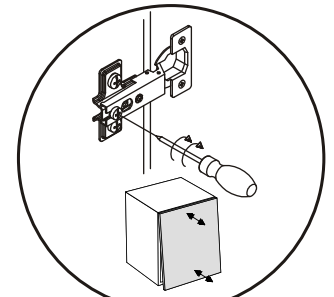
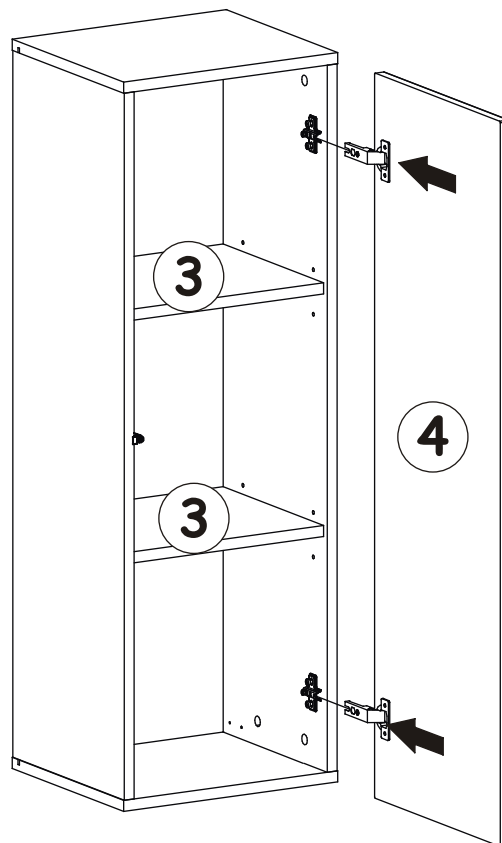

10

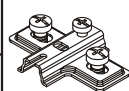

# BLOX TYP 26

E2		Z2		T1	
x2	H=0	x4	Ø5	x1	

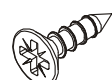
D10	
x2	USØ3,5x13

## 11

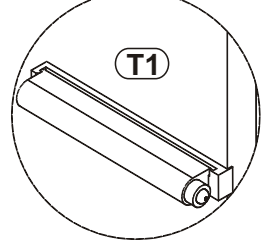
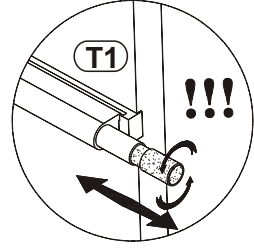
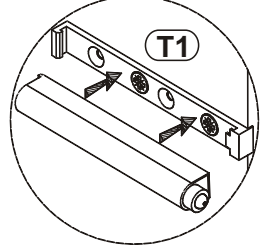
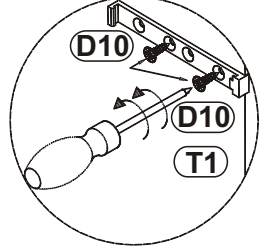
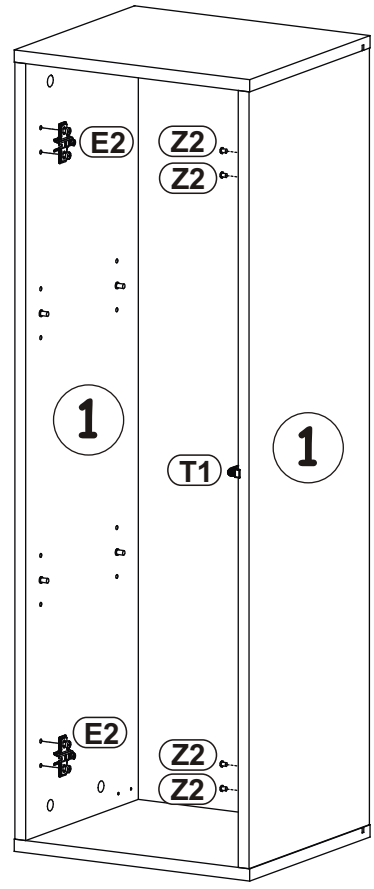
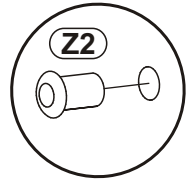
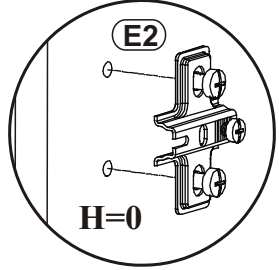
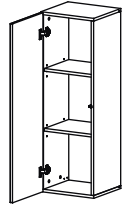

## 12

